

# RZUT PARTERU

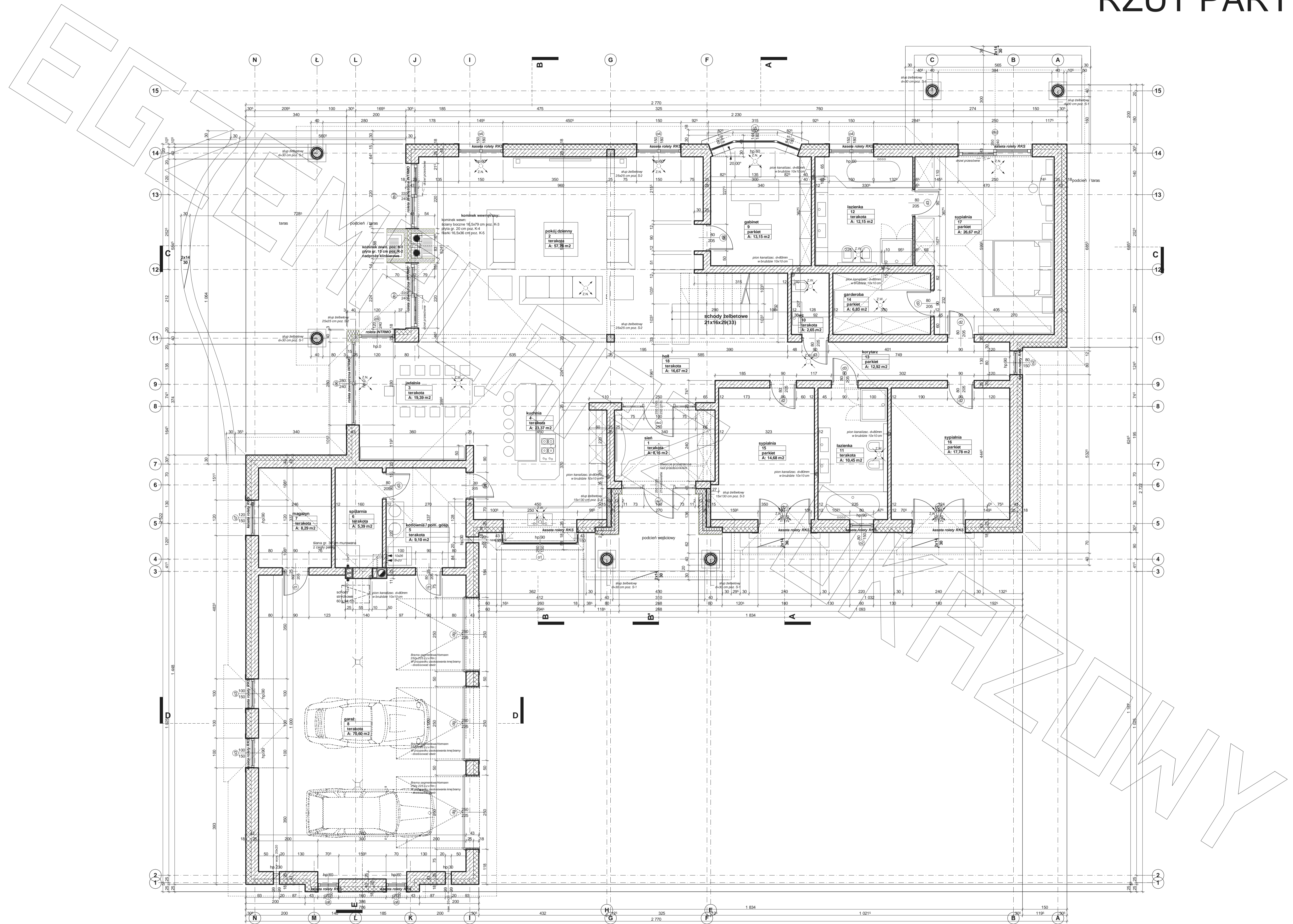

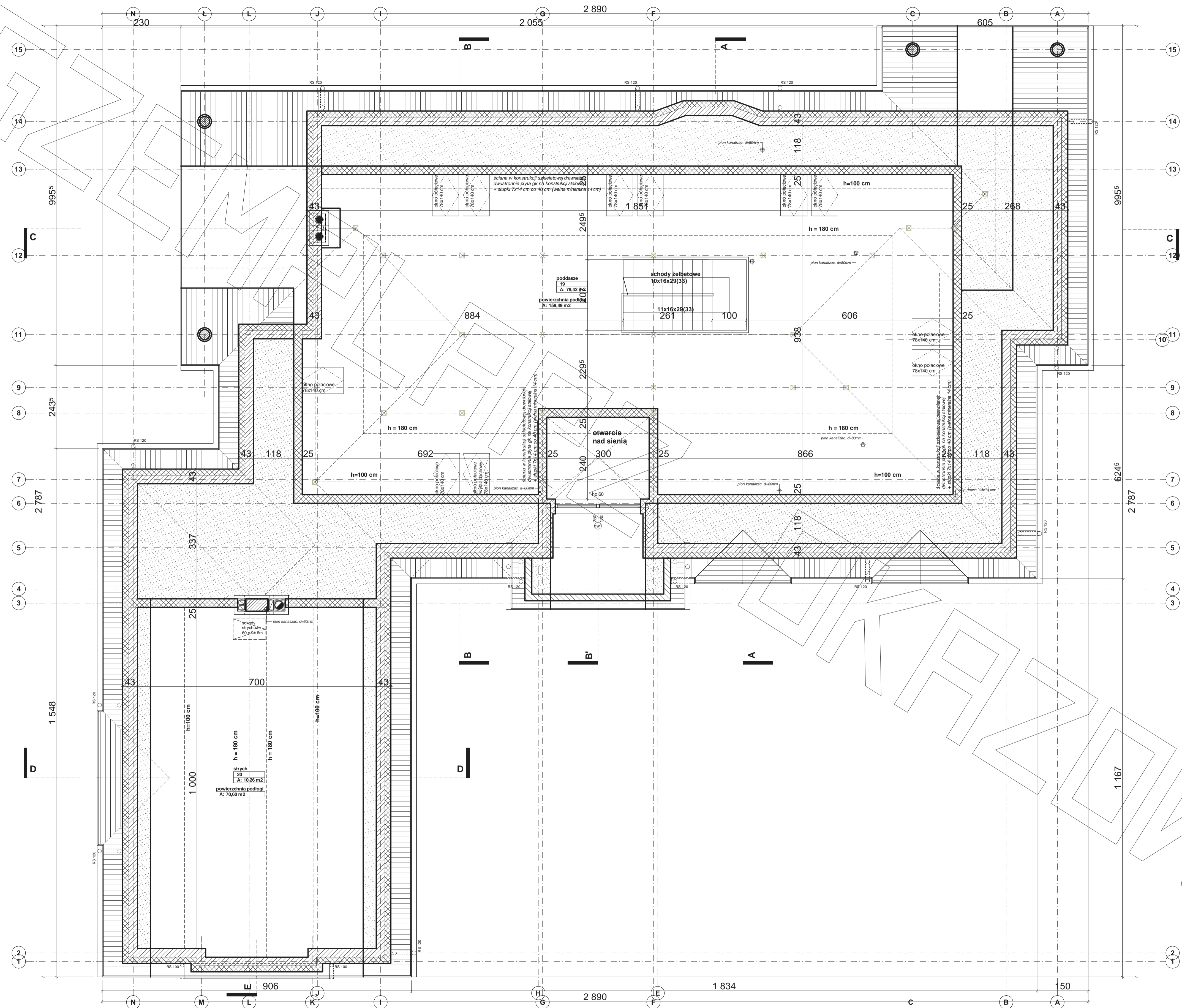

EMPA

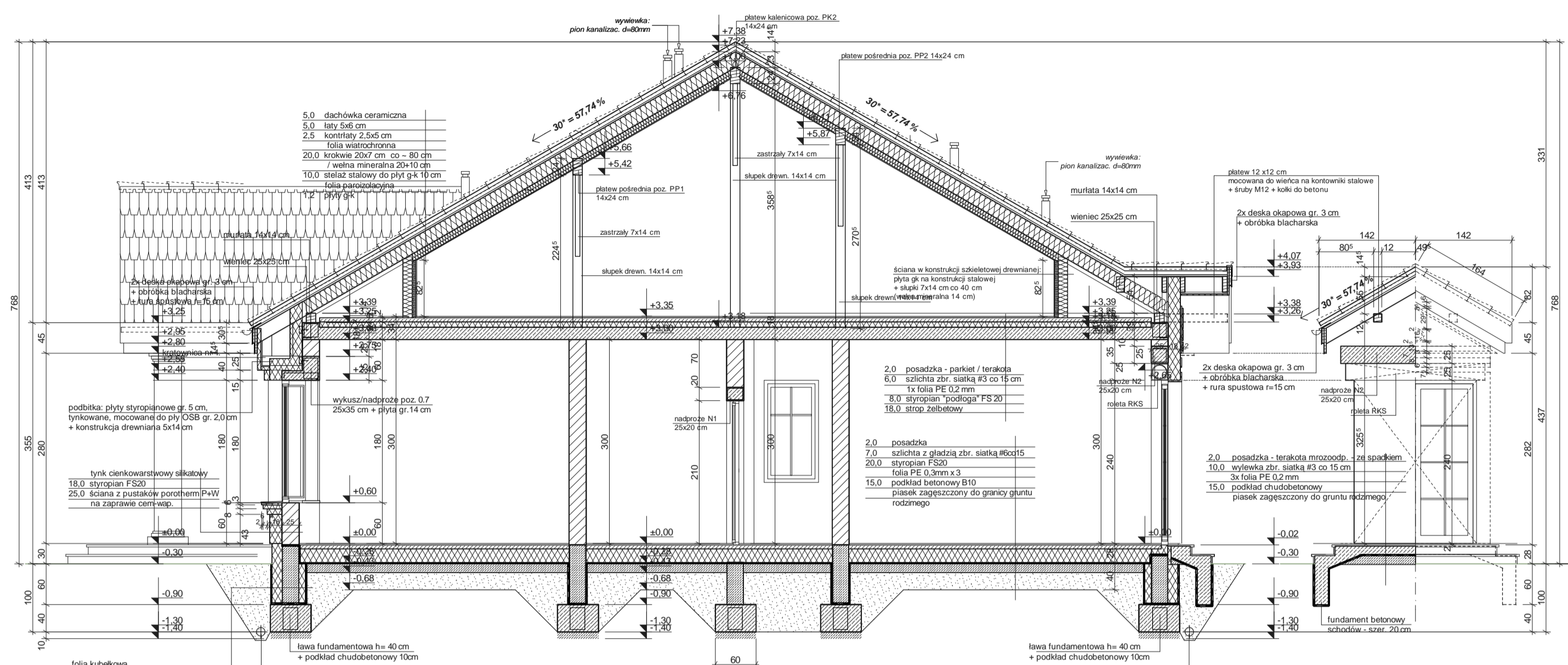

PRZEKRÓJ A-A

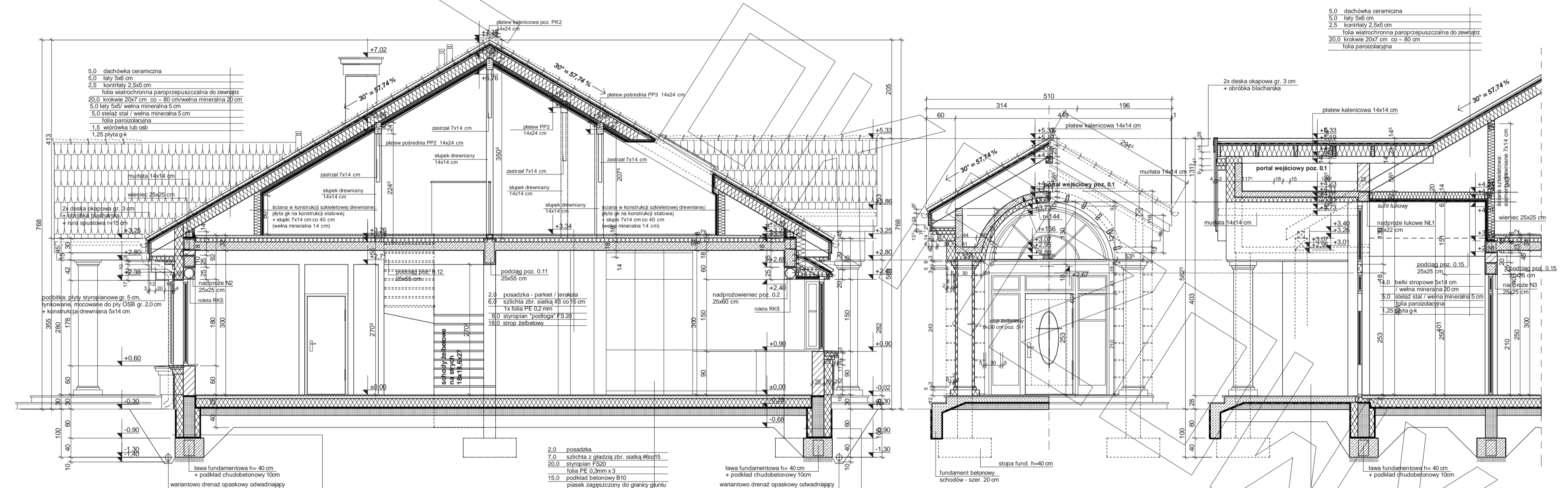

PRZEKRÓJ B-B

PRZEKRÓJ B'

# PRZEKRÓJ

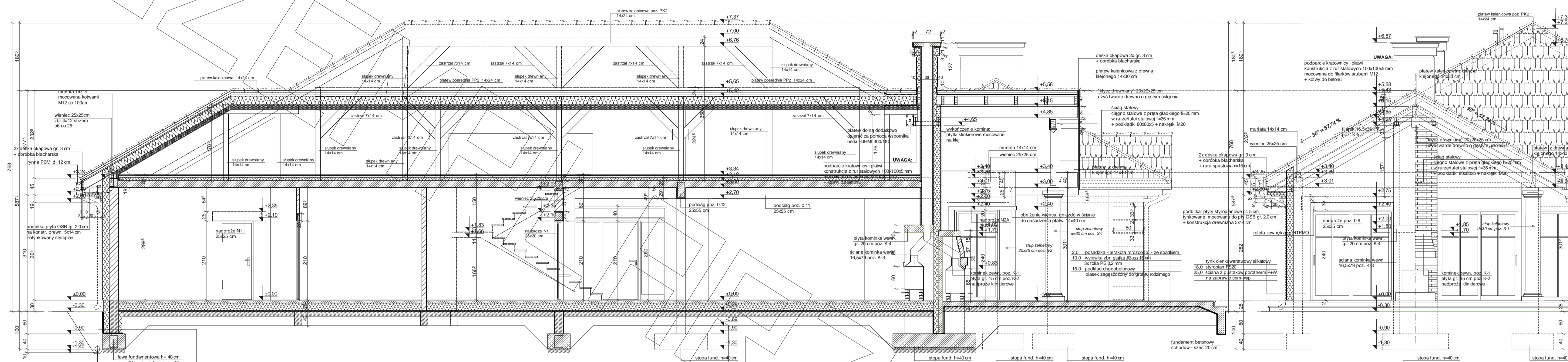
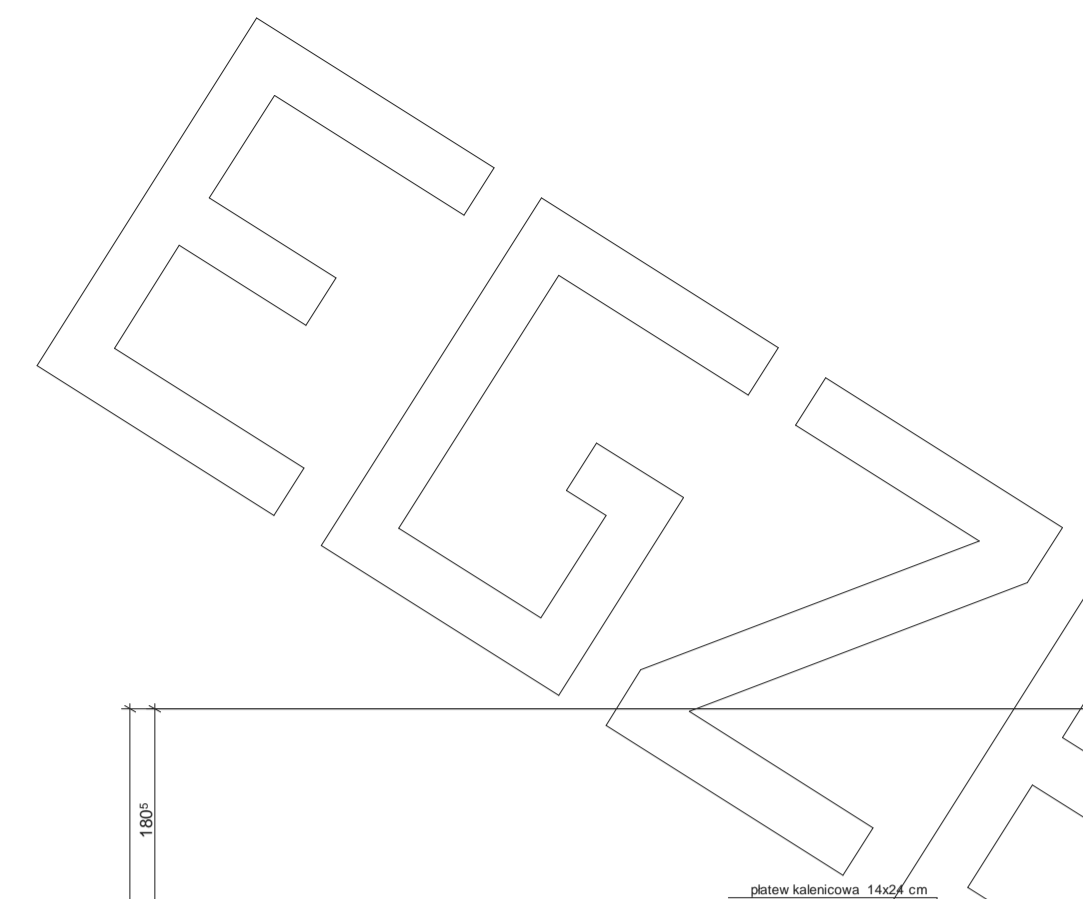

- 10.0 trypaner elastyczny - np. "Isopanel" Omega
- folia parozachłonna - preparat niefeliks 2x
- zaprawa klejowa na siance wstę 2x
- 15.0 trypaner Omega Fundament - gąsź lub styrodur ekstrudowany
- 24.0 skłania z bloczków betonowych gr. 24 cm - na żwir, cement
- folia przeciwwilgociowa - preparat niefeliks 2x

- 5.0 dachówka ceramiczna
- 5.0 lity 140 cm
- 2.5 kontyrlak 2,565 cm
- folia wlotochronna pancerzopuszczalna do zewnetrz
- 20.0 łokwka 20x7 cm. co - 80 cm
- 5.0 kornis stalowy 80 x 4-wersja 5 cm
- folia parozachłonna
- 1.2 płyta GK

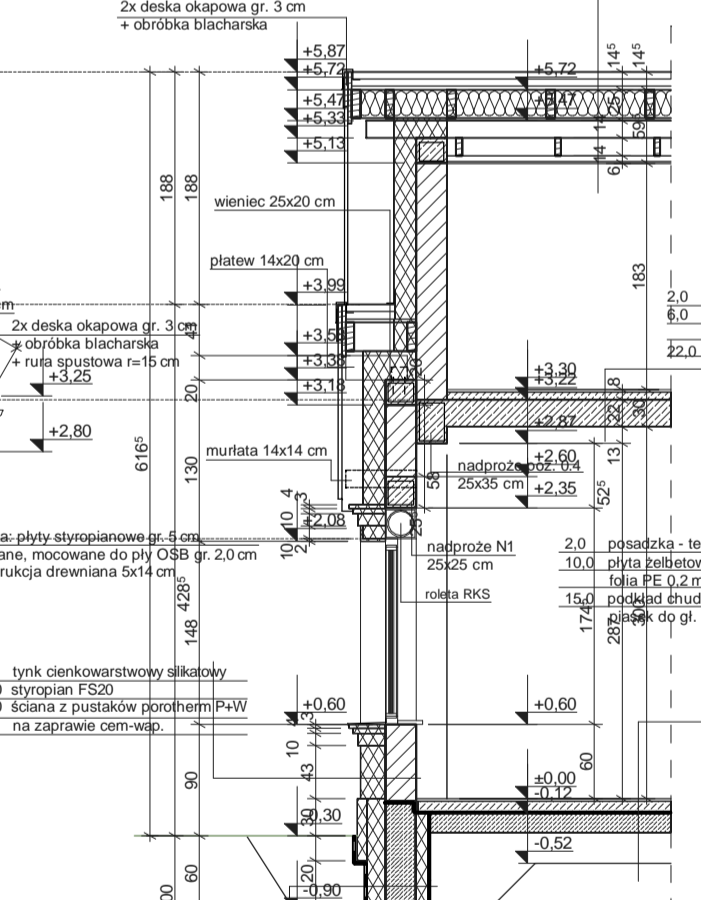
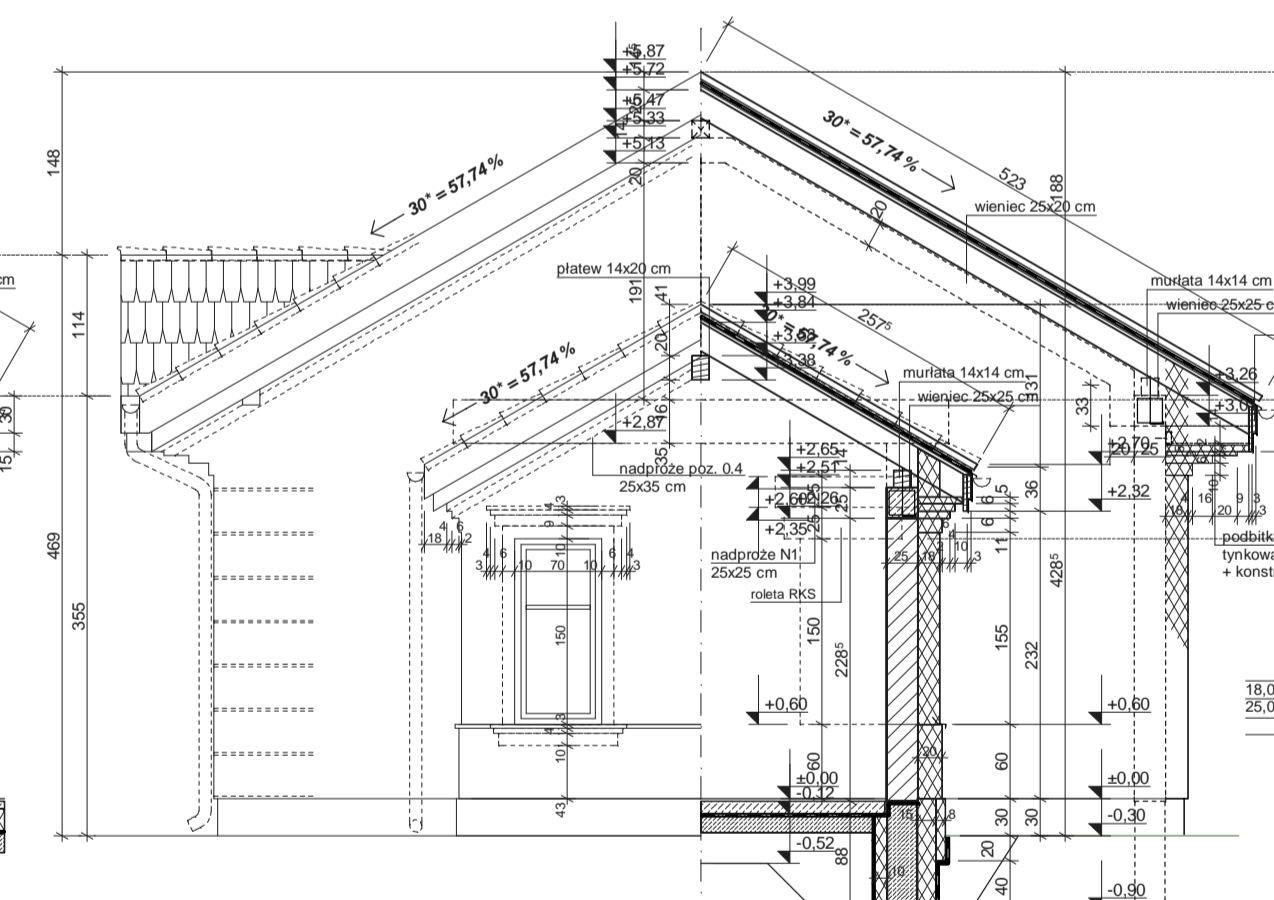
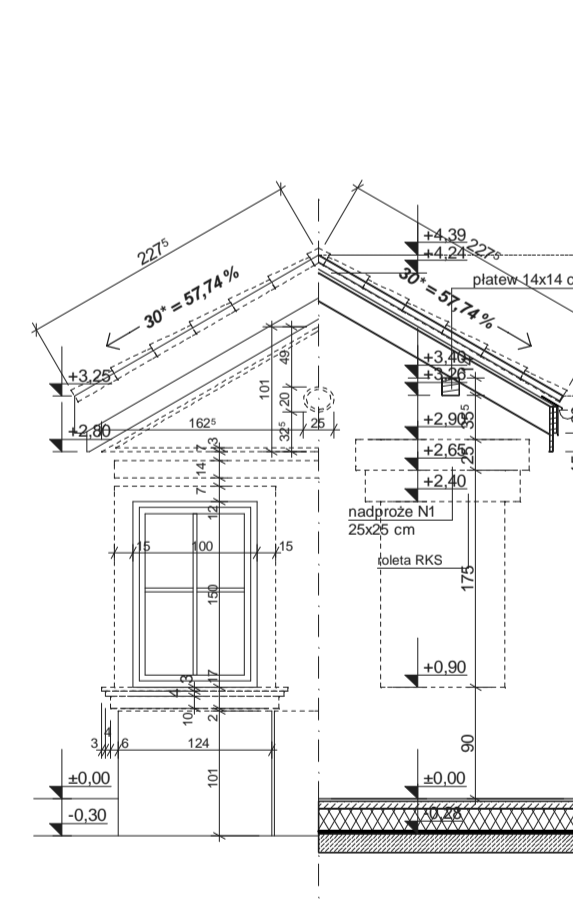

PRZEKRÓJ E

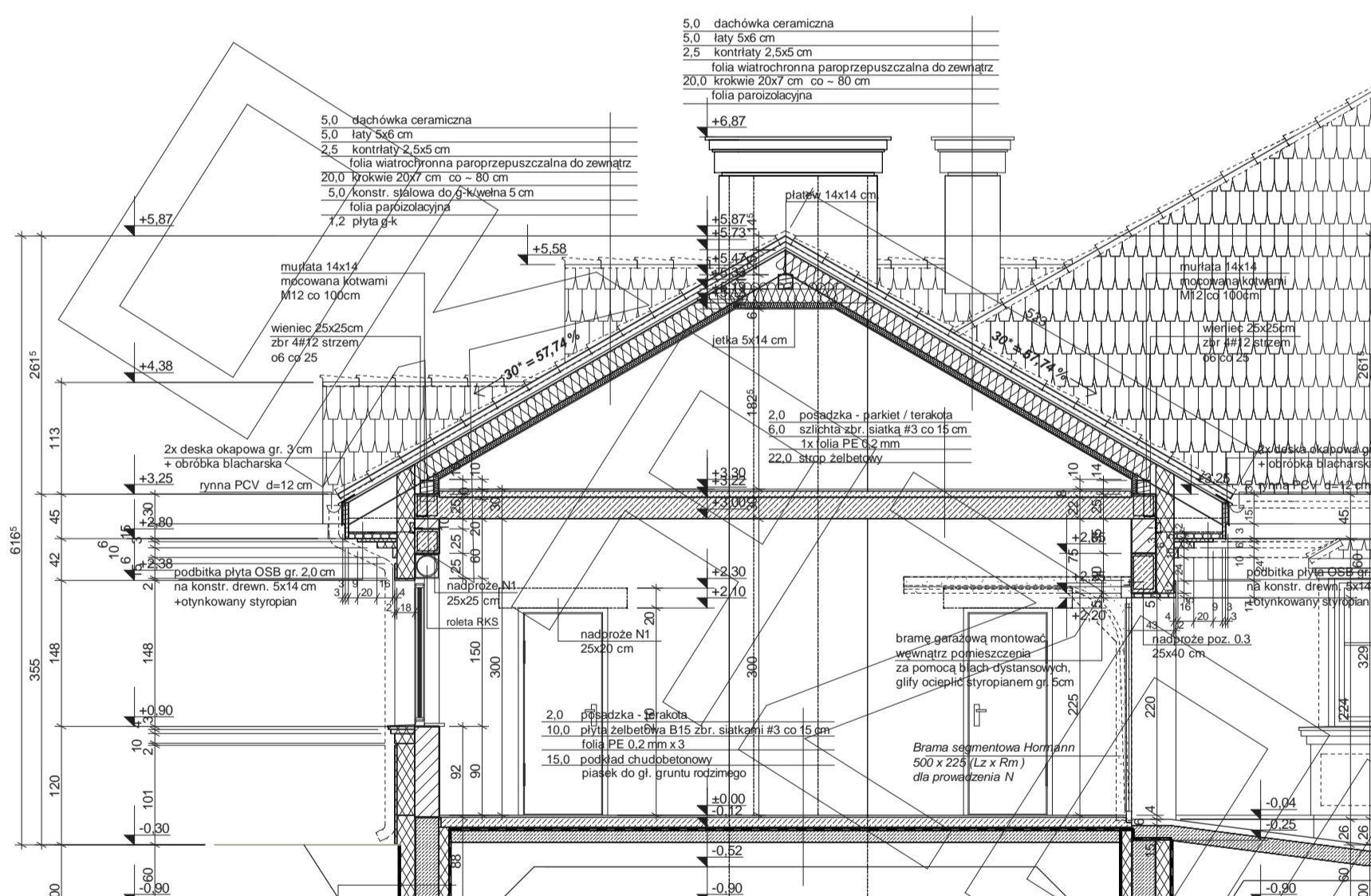

PRZEKRÓJ D-D



ELEWACJA FRONTOWA

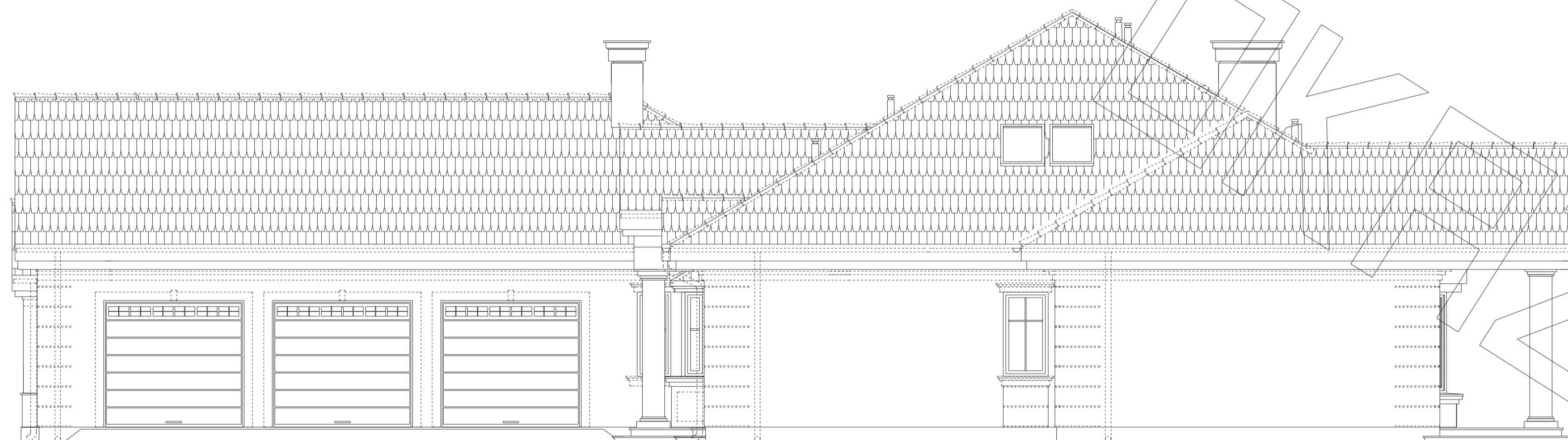

ELEWACJA BOCZNA

