

Branka szklana Homim  
50x 220 (4-2m) dla prowadzenia N  
Kłamy okiennic w rzędy 505 i 508 (wysokość  
228 licząc od wewnętrznej krawędzi)  
wewnętrzna i zewnętrzna  
obrotowa ściana fundamentowa  
do spodu nadproża 40cm  
ściana garażowa masywna - wspaniał  
poręczająca za pomocą blach dystansowych  
- gładki opank polipropilenu gr. 3cm  
- w rzędy mostki termiczne izolowane styropor  
w murze

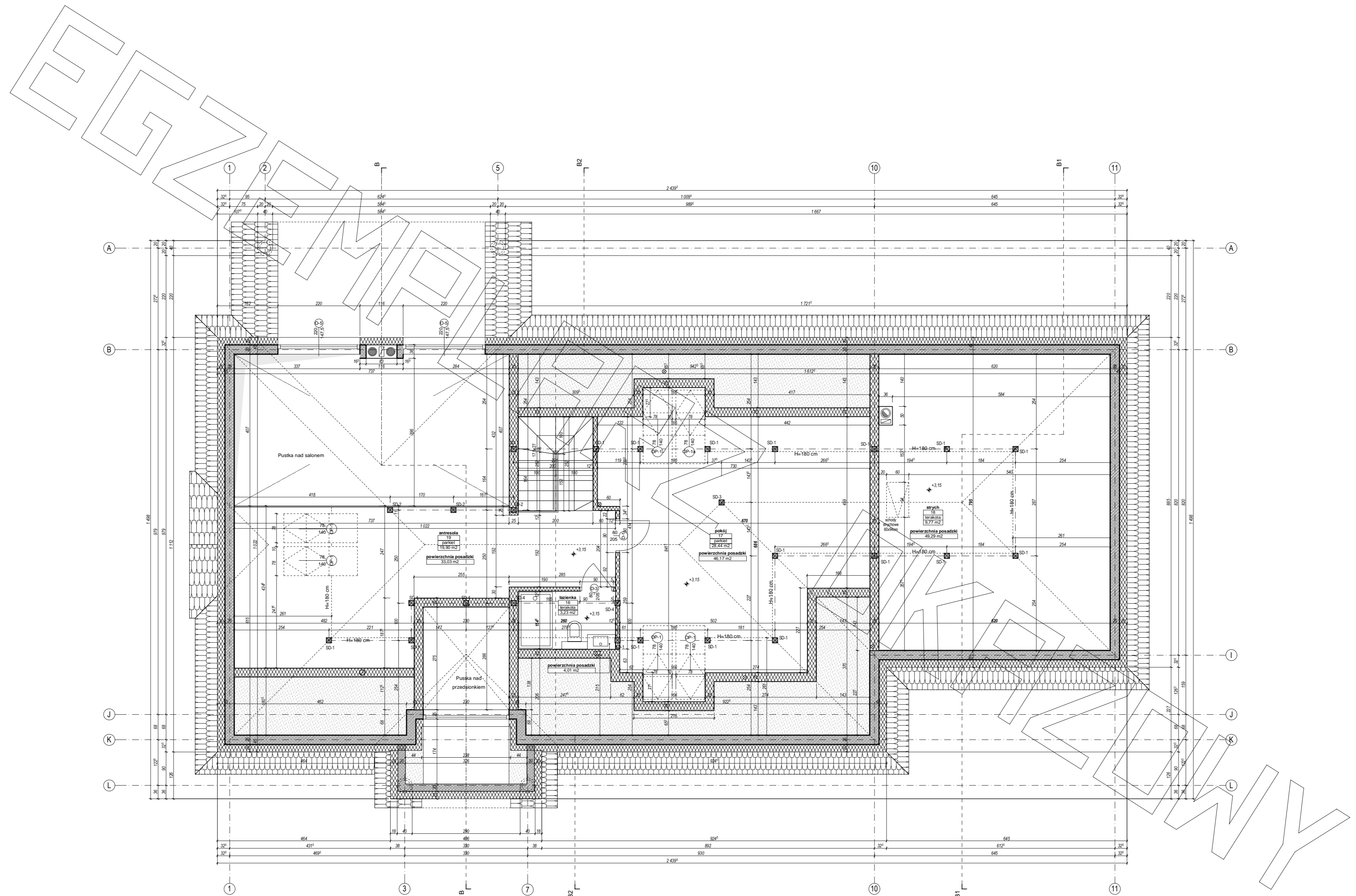

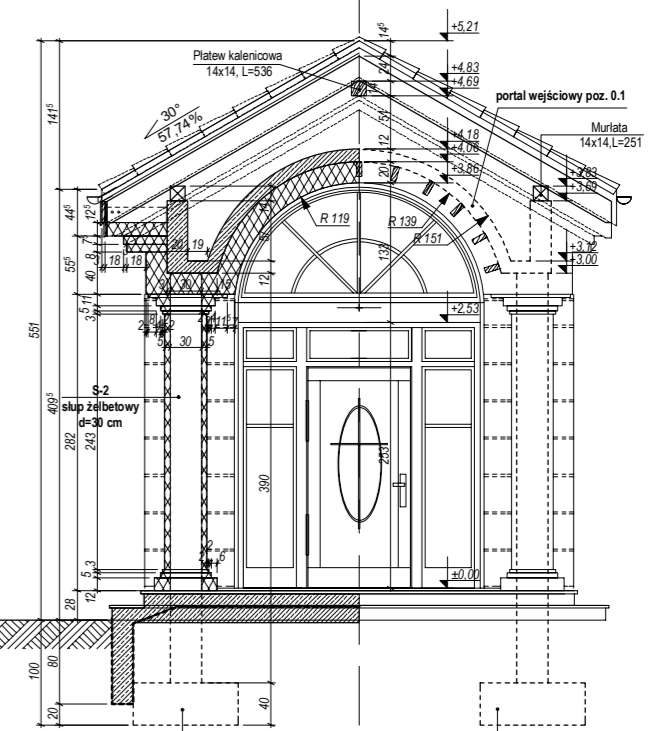

PRZEKRÓJ B2 - B2

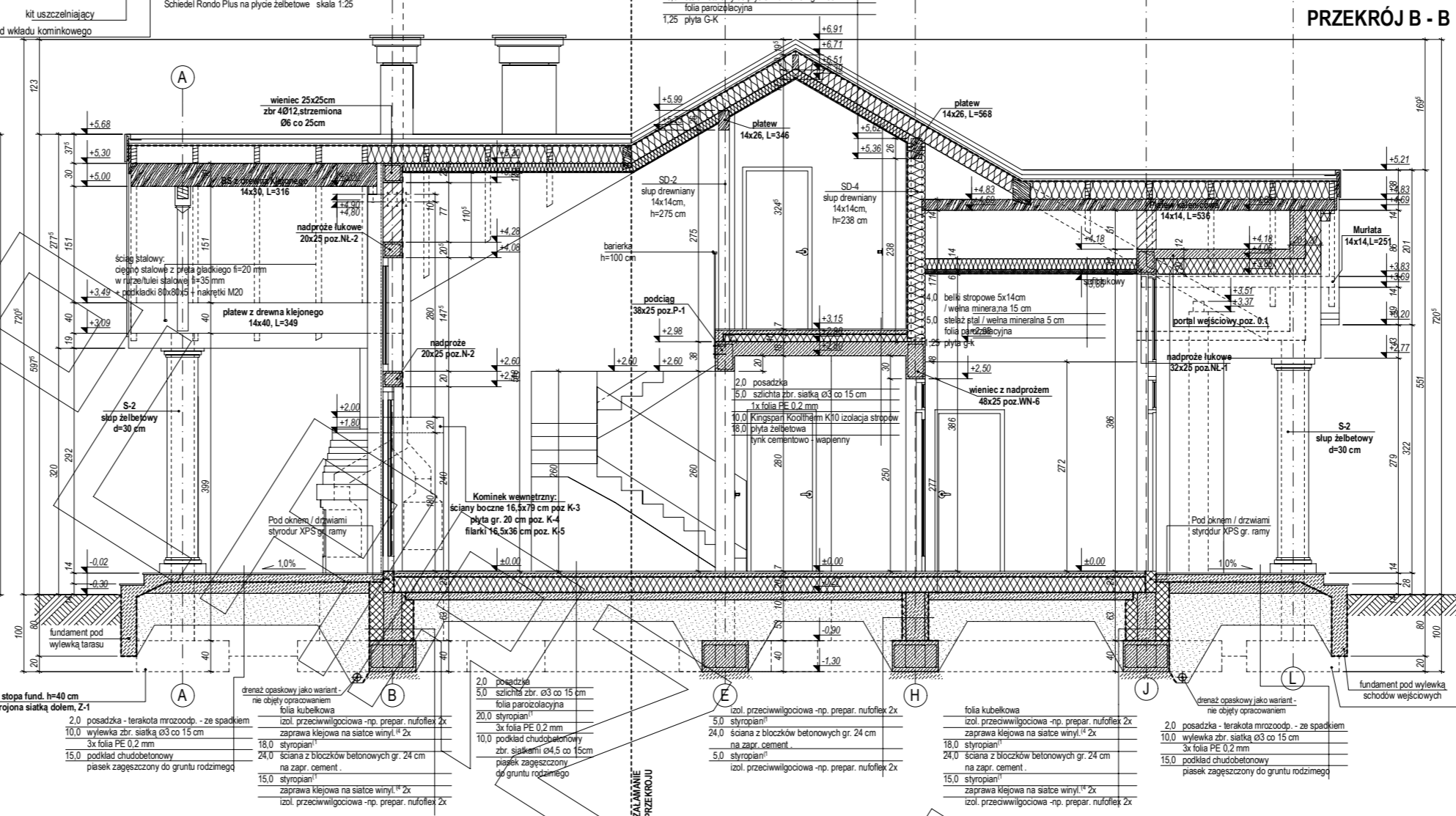
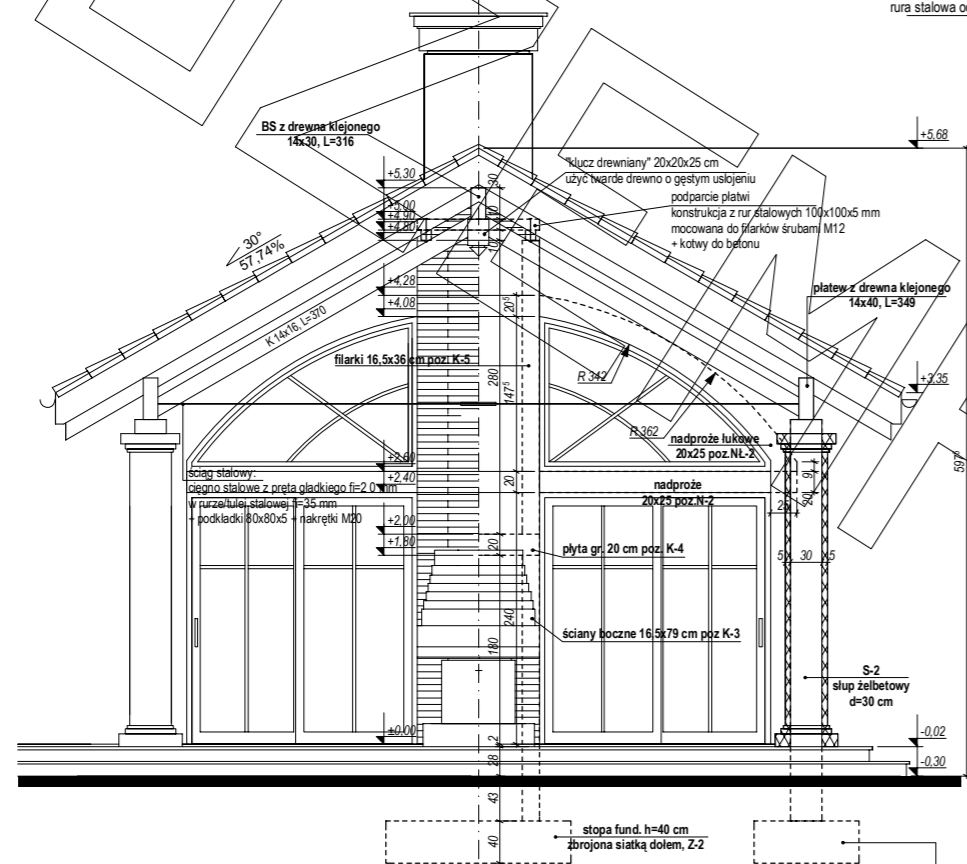
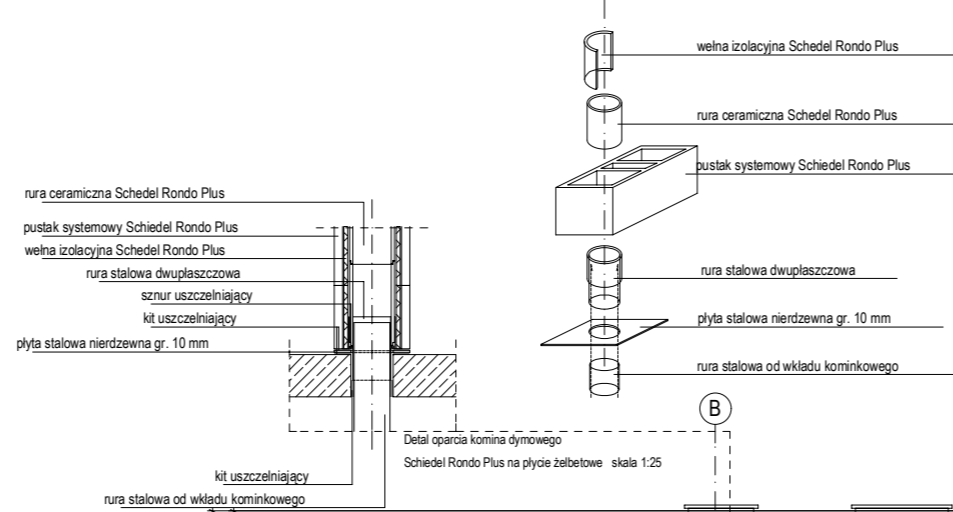
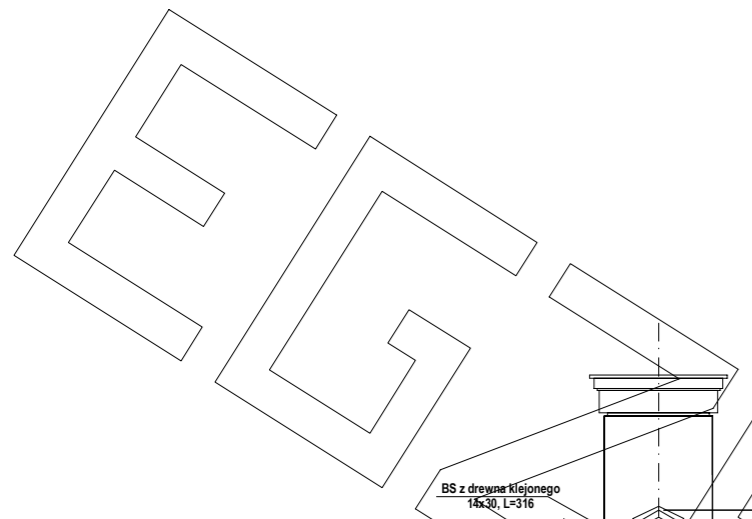
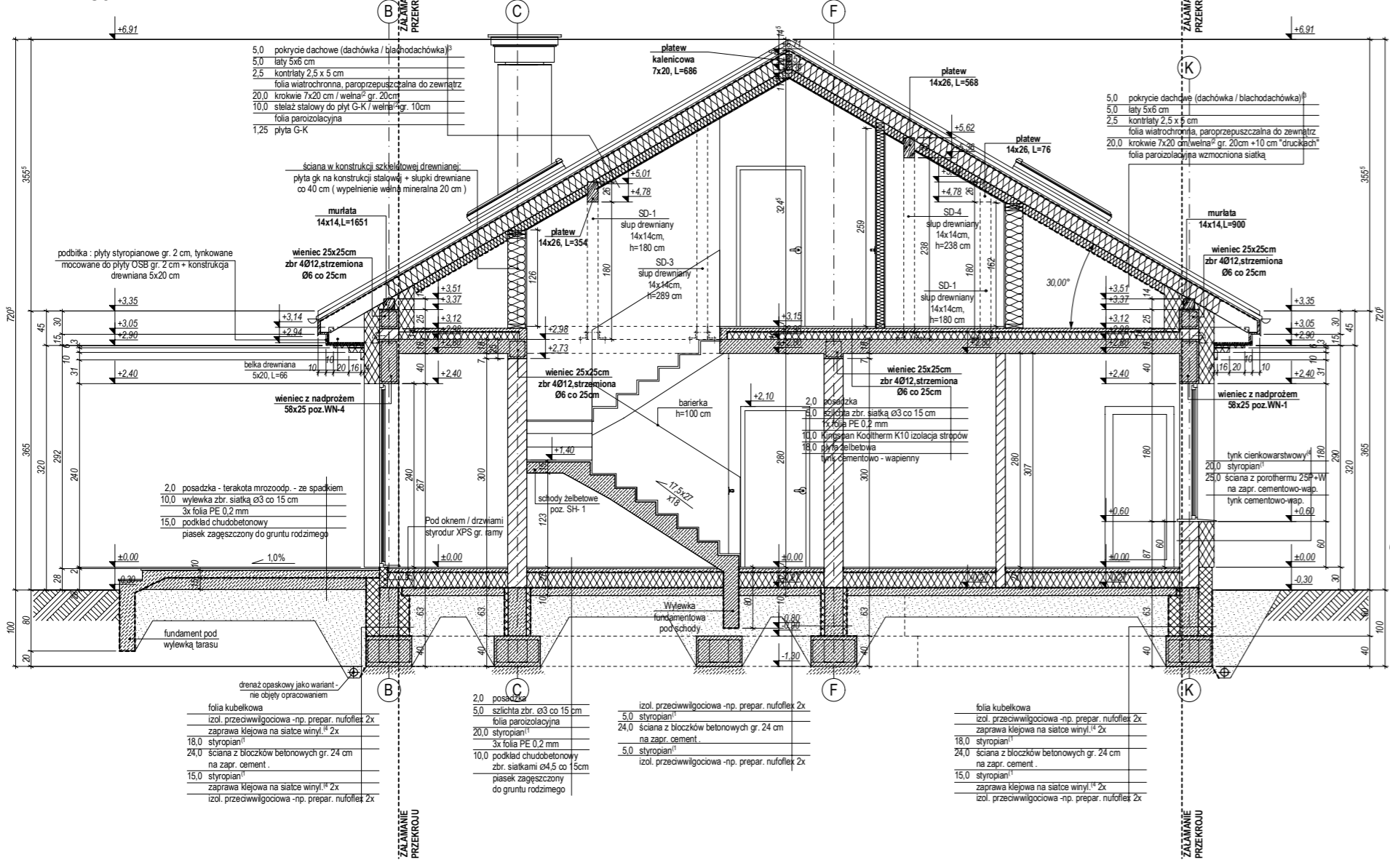

PRZEKRÓJ PRZEZ WYKUSZ KUCHENNY

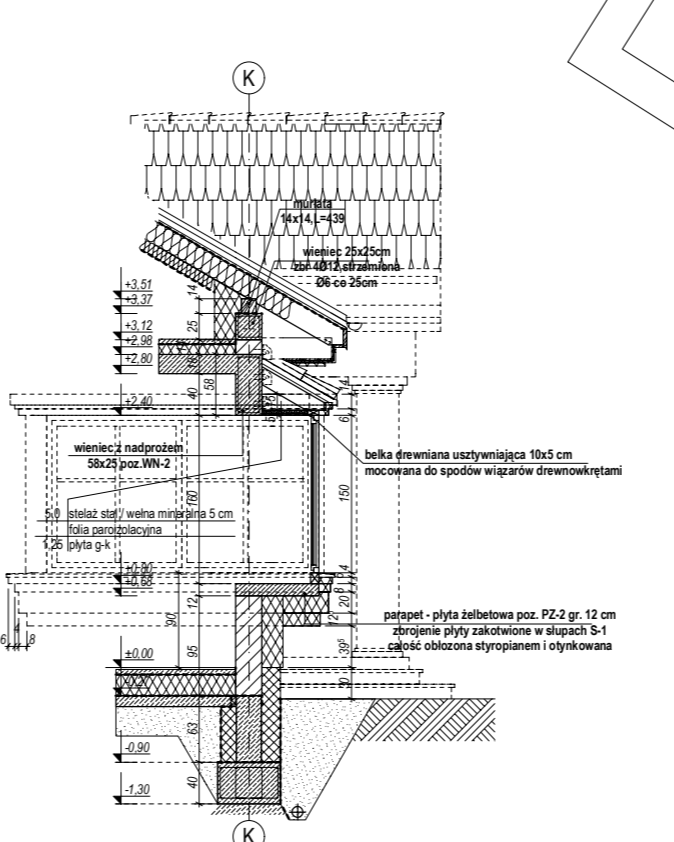

PRZEKRÓJ B1 - B1

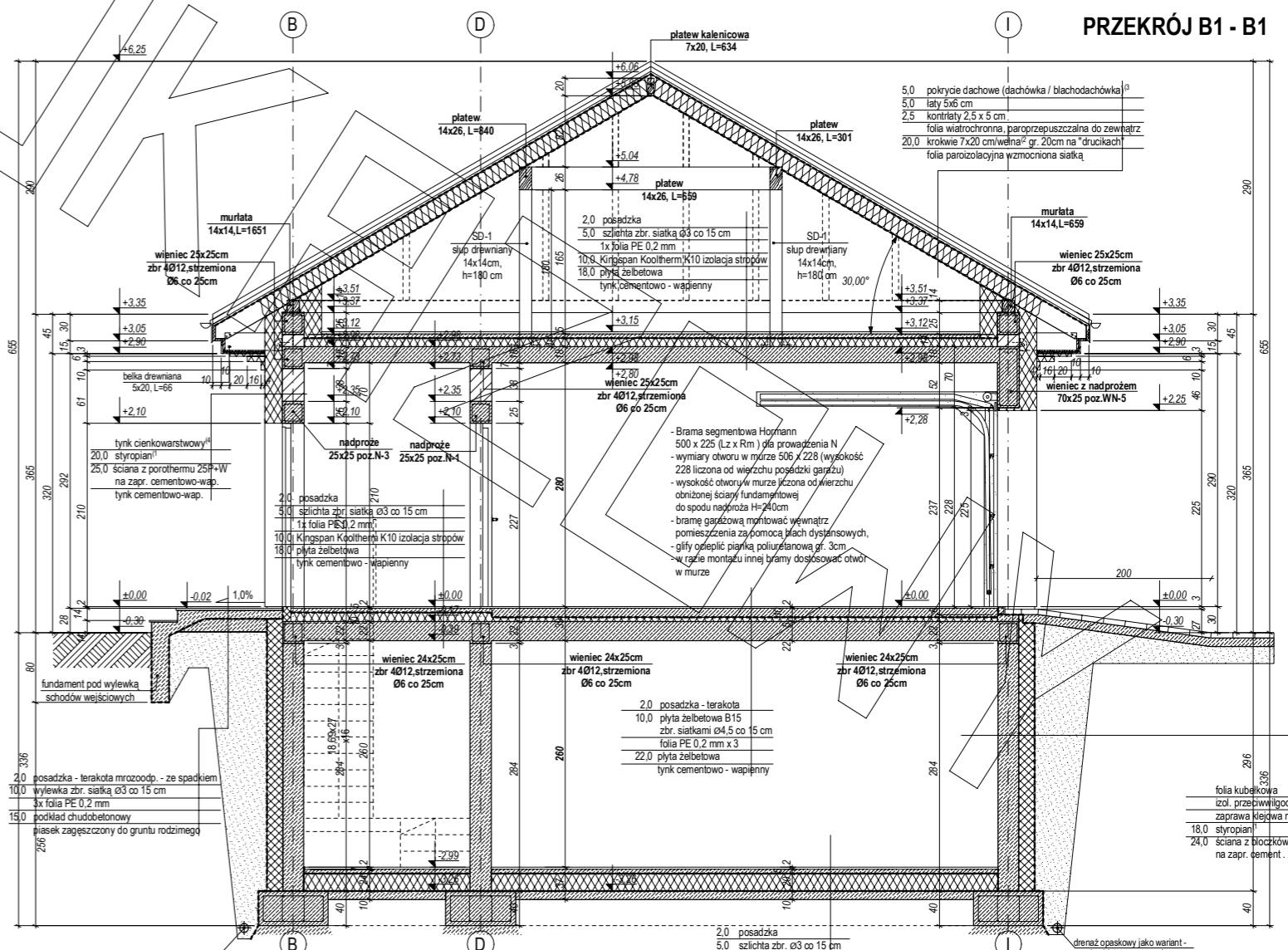

ELEWACJA

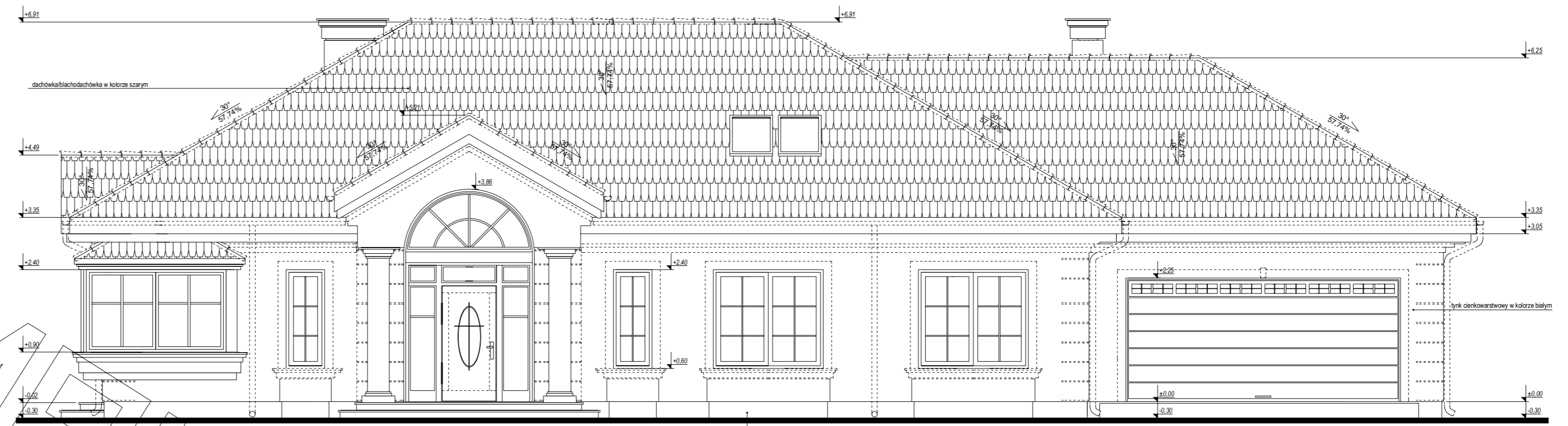

ELEWACJA FRONTOWA:

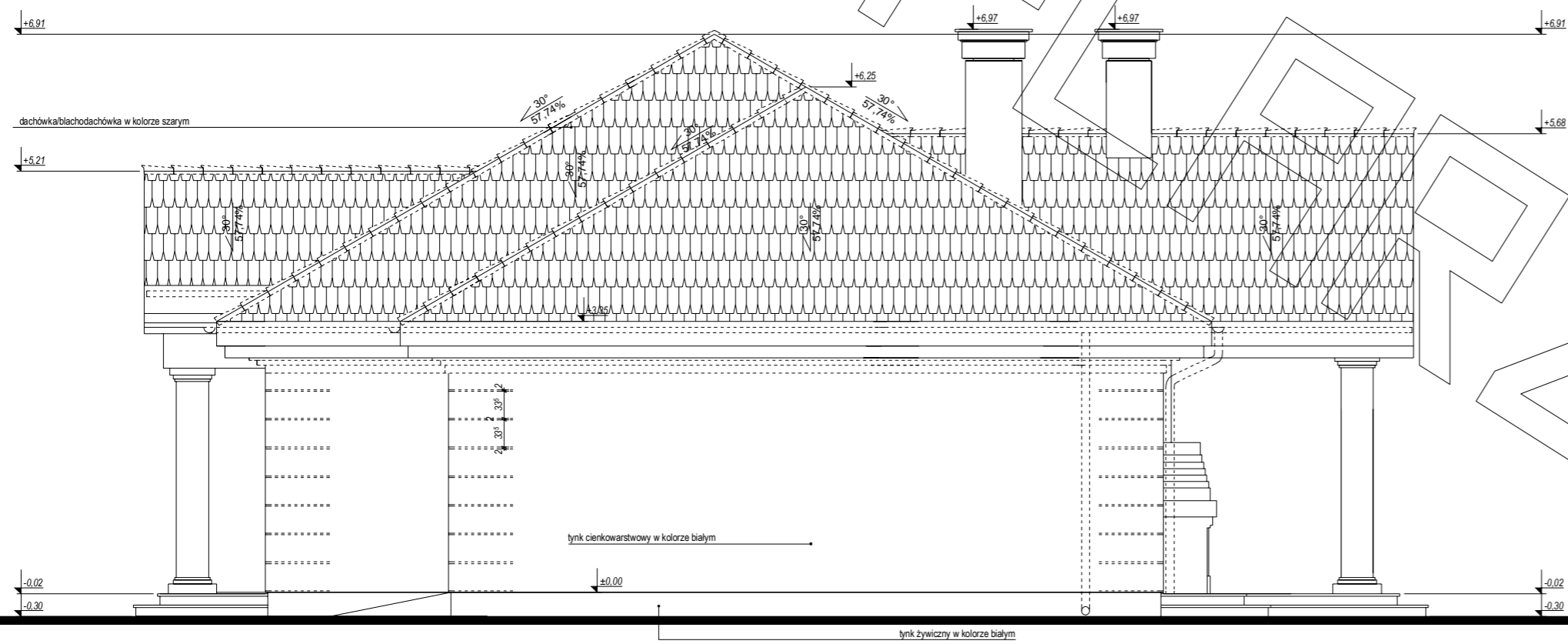

ELEWACJA BOCZNA:



ELEWACJA BOCZNA:

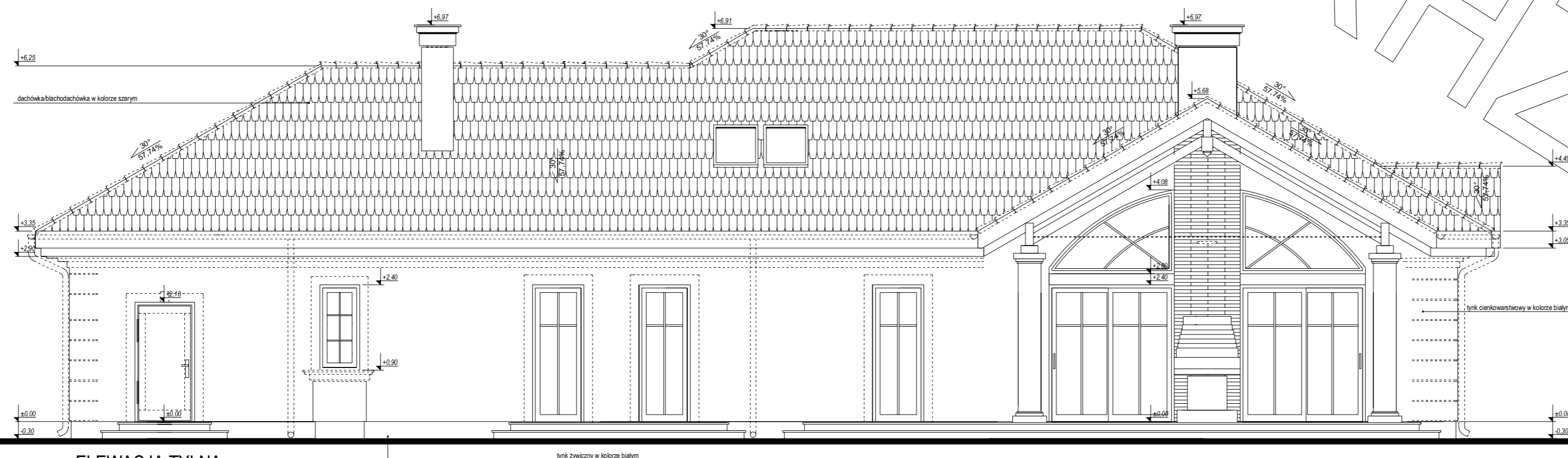

ELEWACJA TYLNA:

RAZDROWY