

RZUT PARTERU

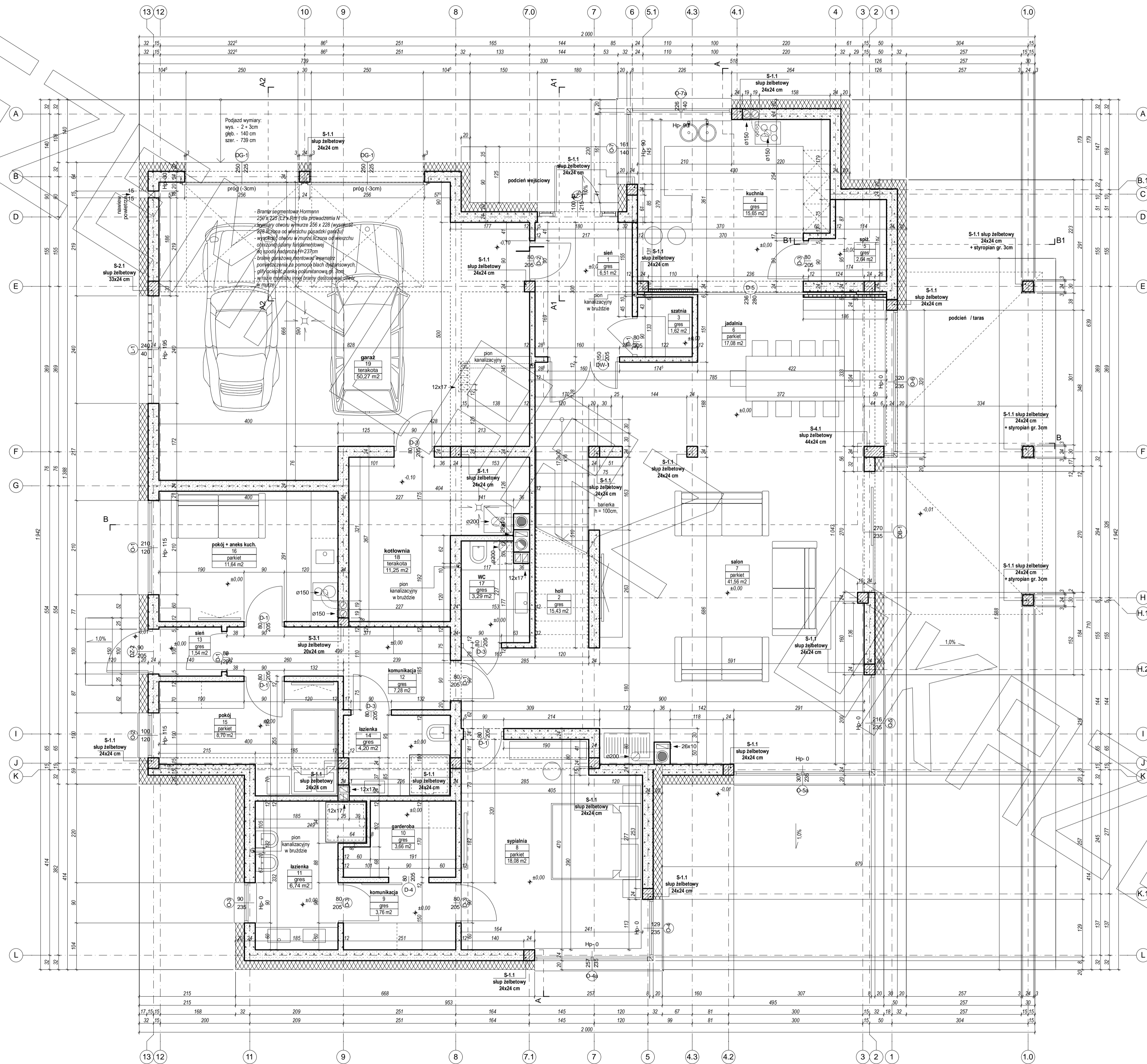

RZUT PIĘTRA

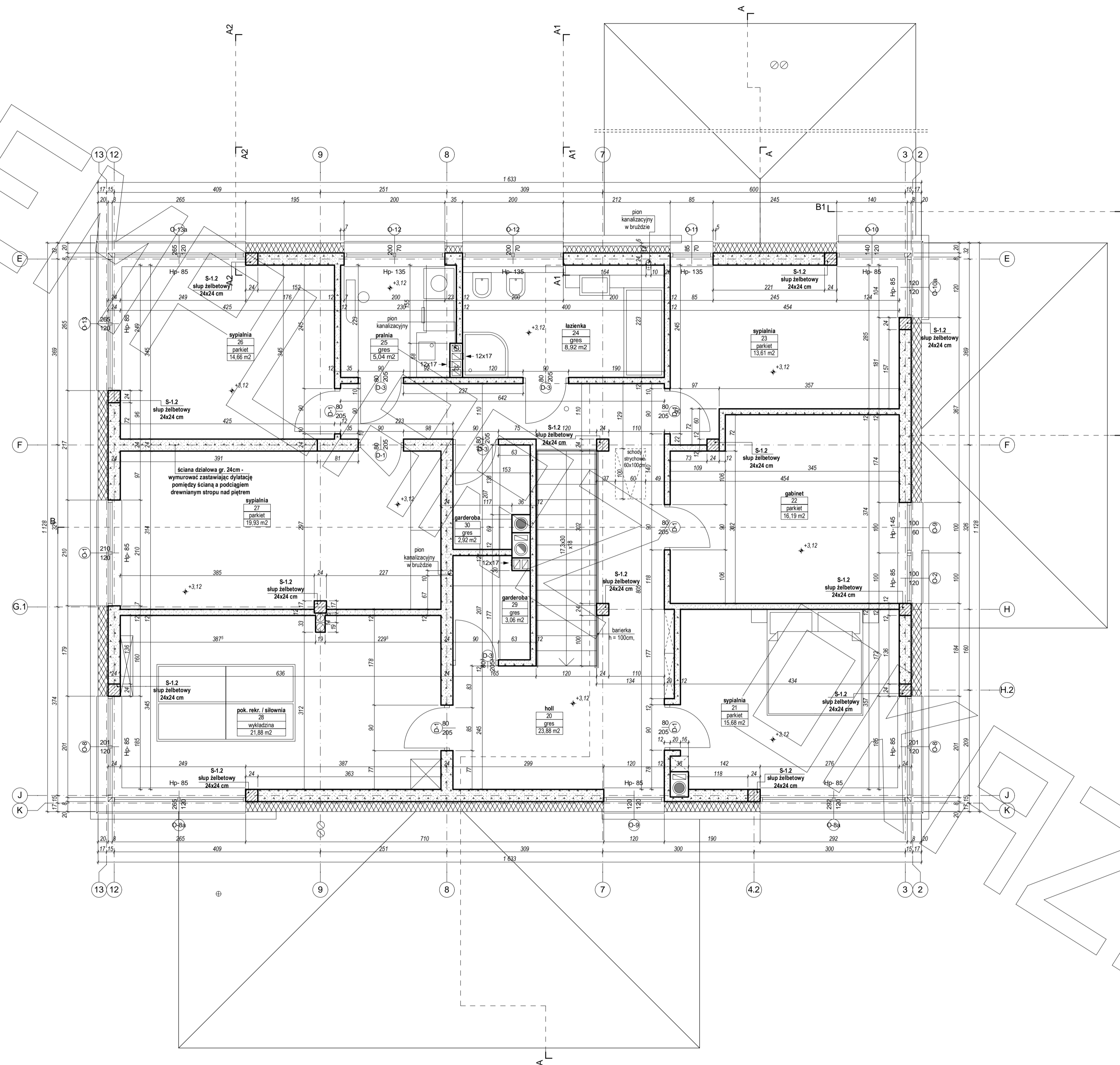

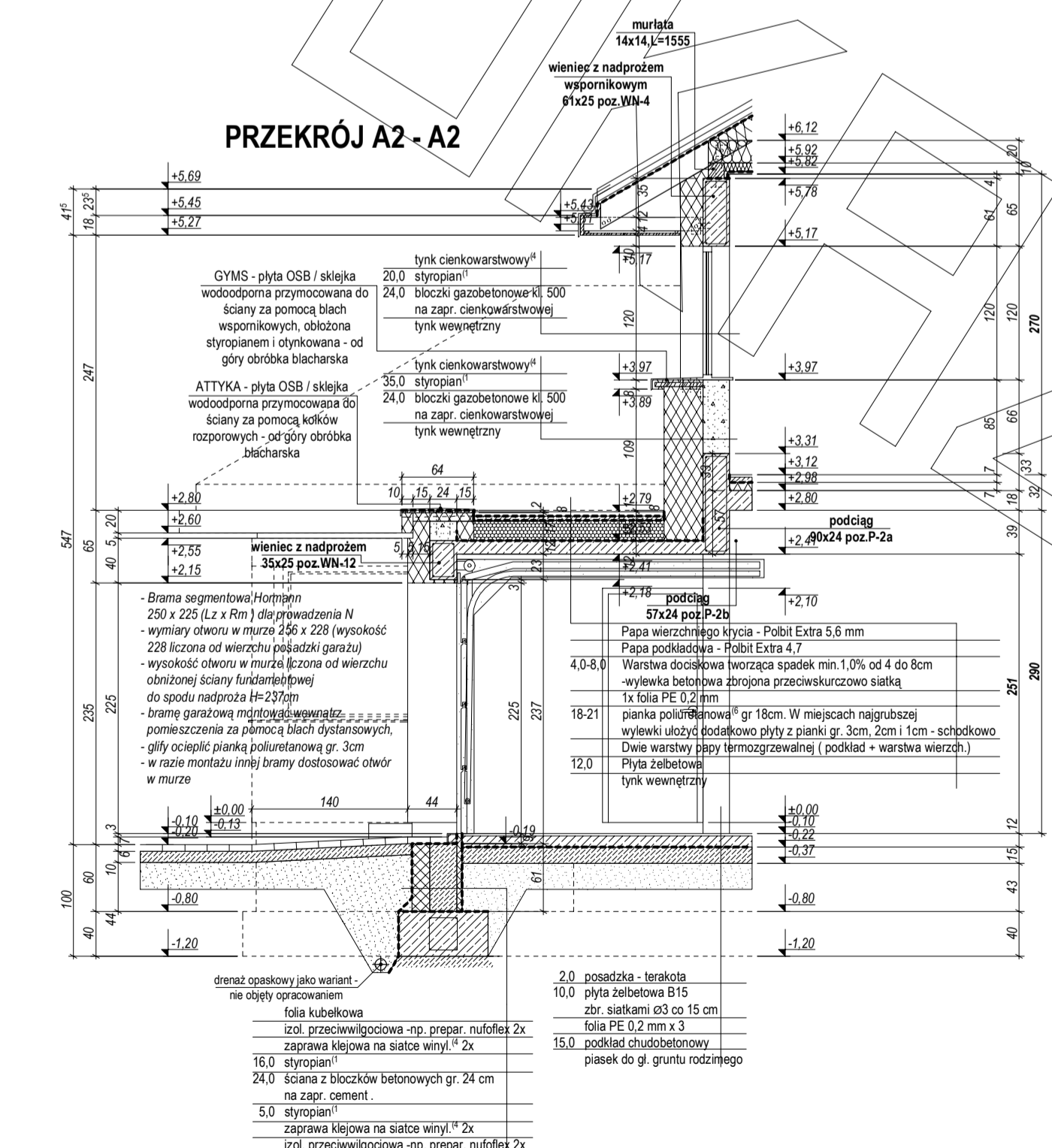
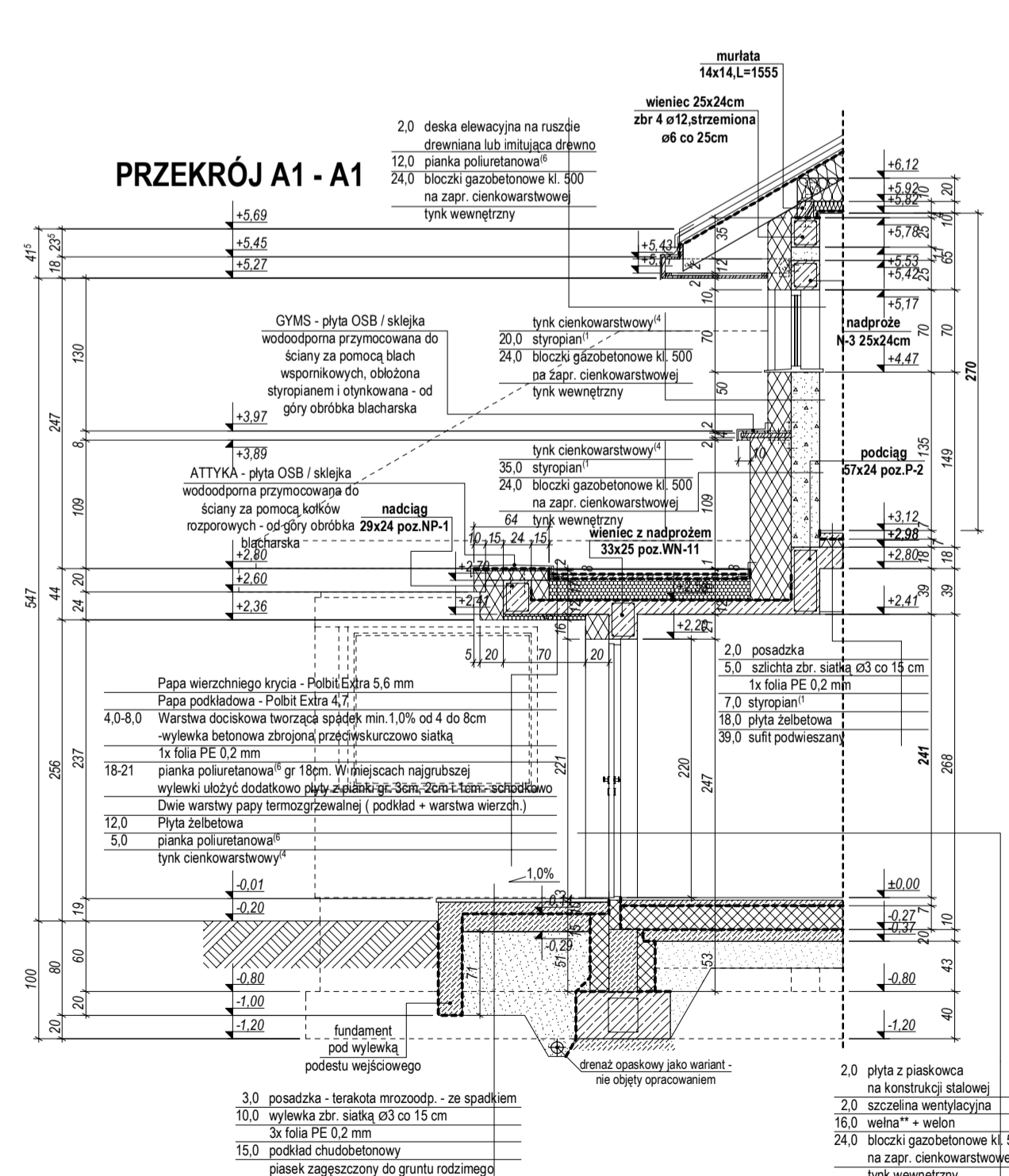
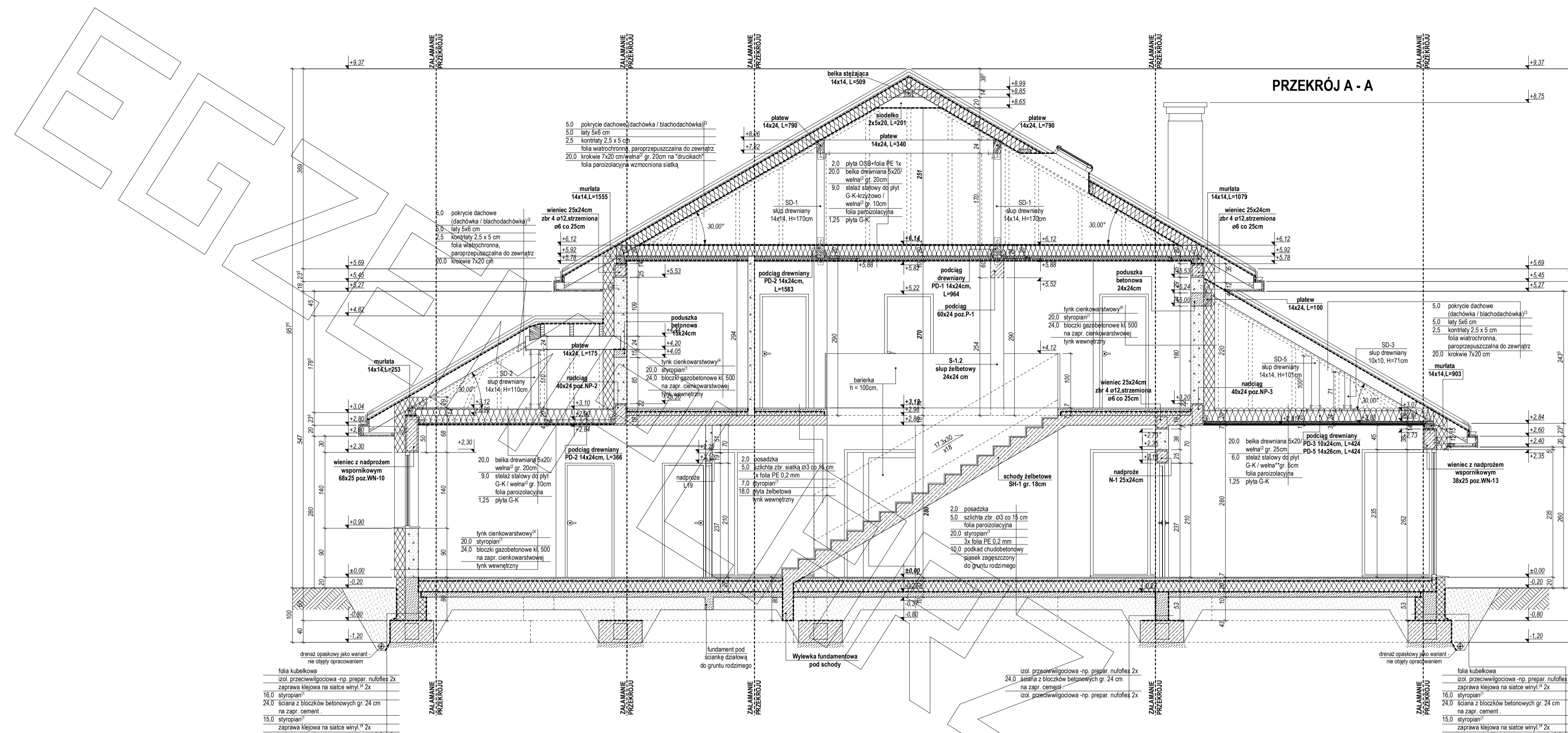

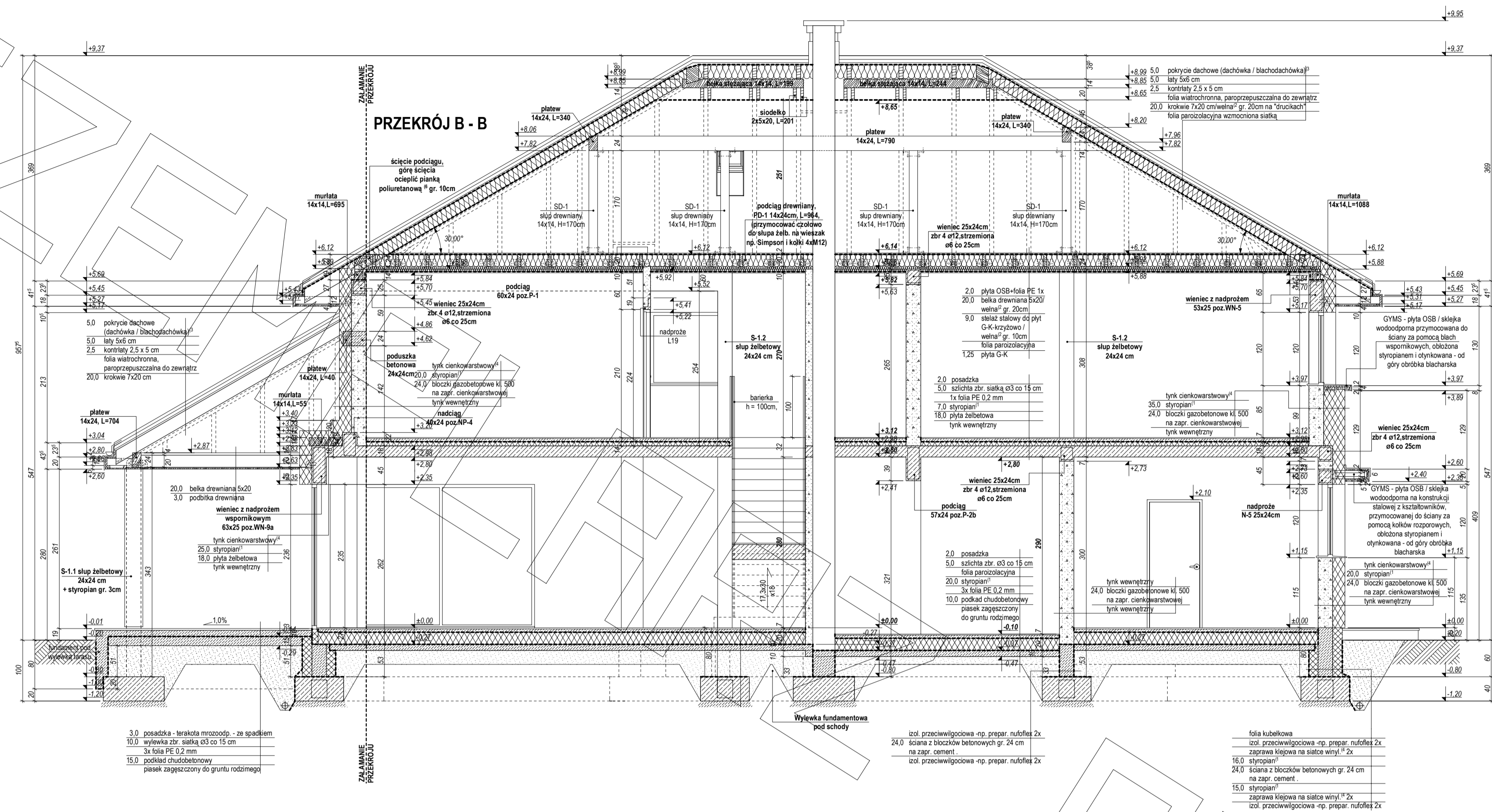

PRZEKRÓJ B1 - B1

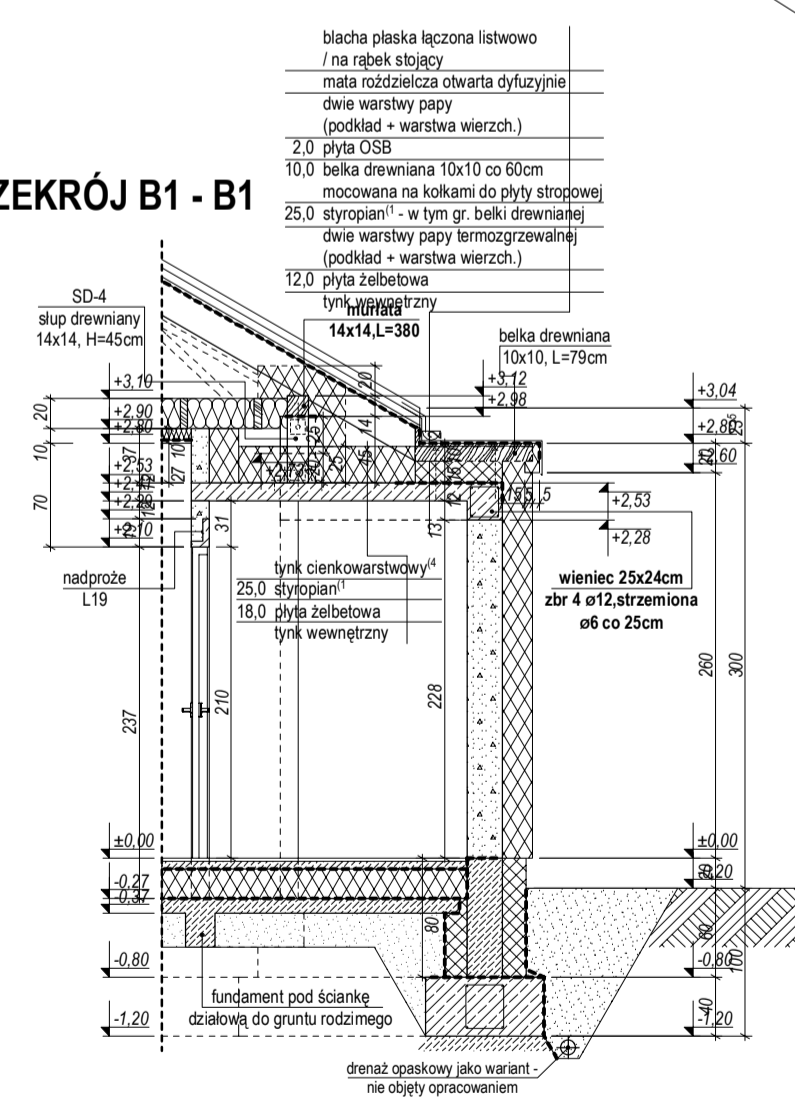

ELEWACJE

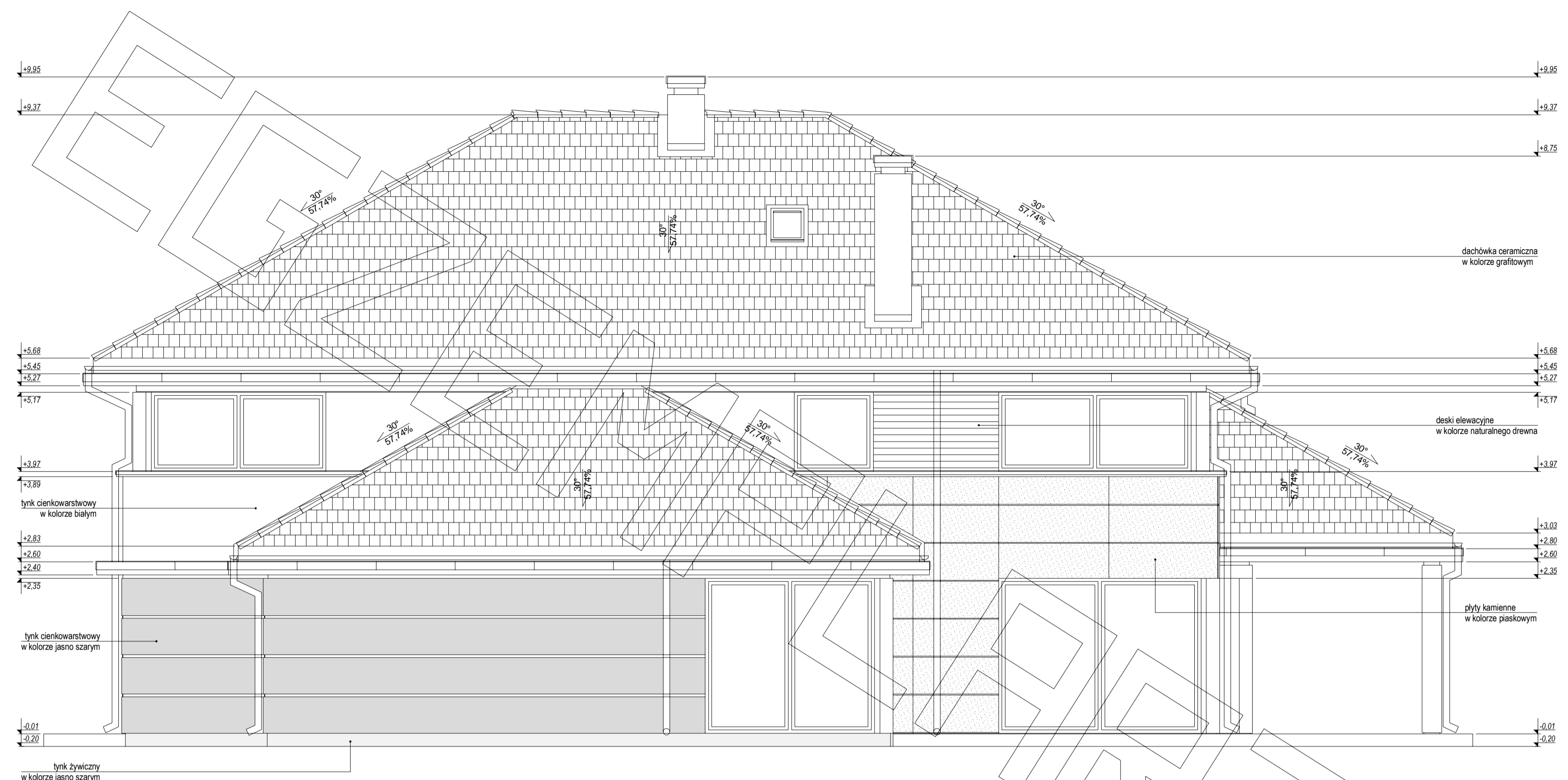

ELEWACJE

