

PROJEKT

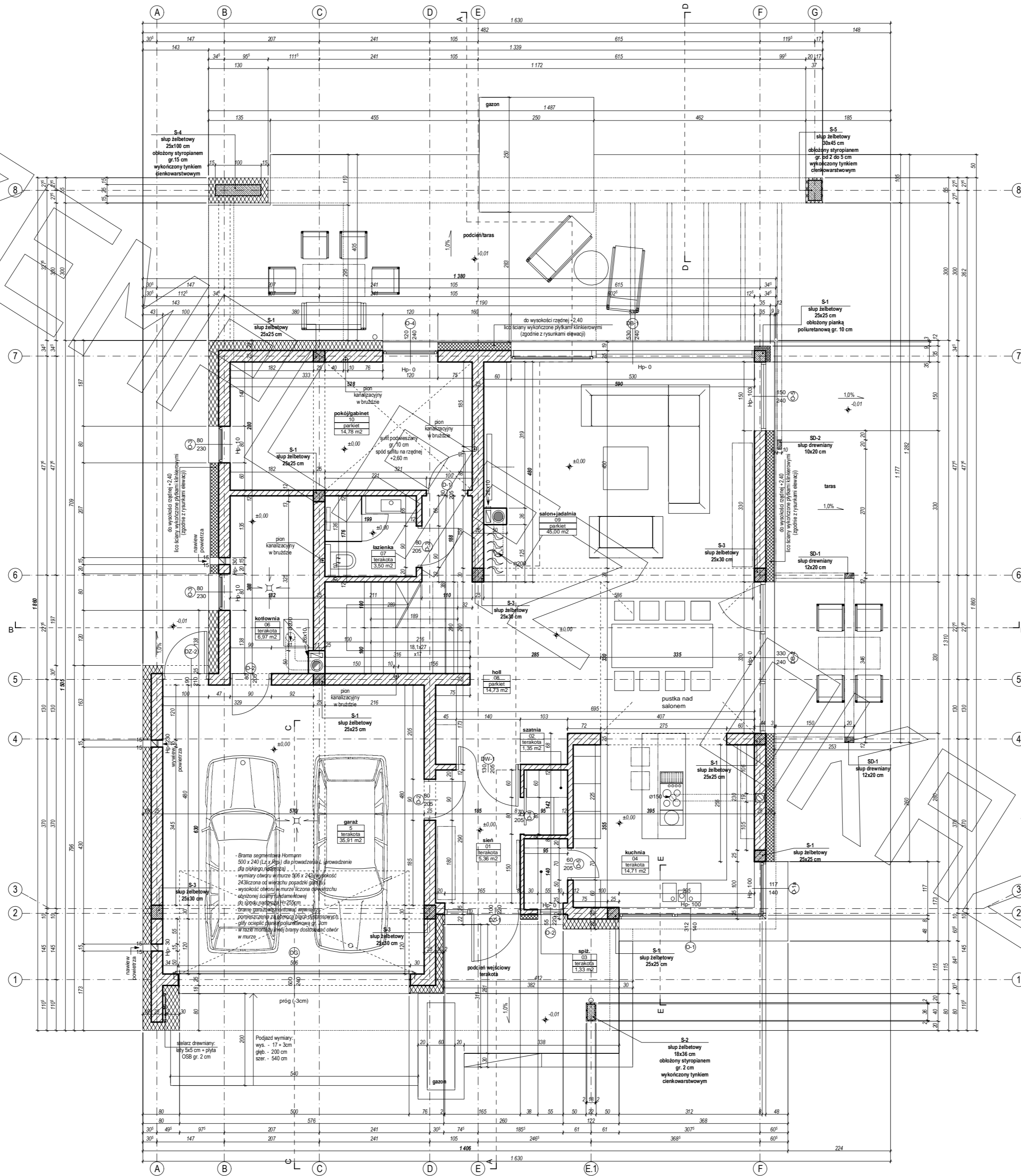

PROJEKT

ARCHITECTURA

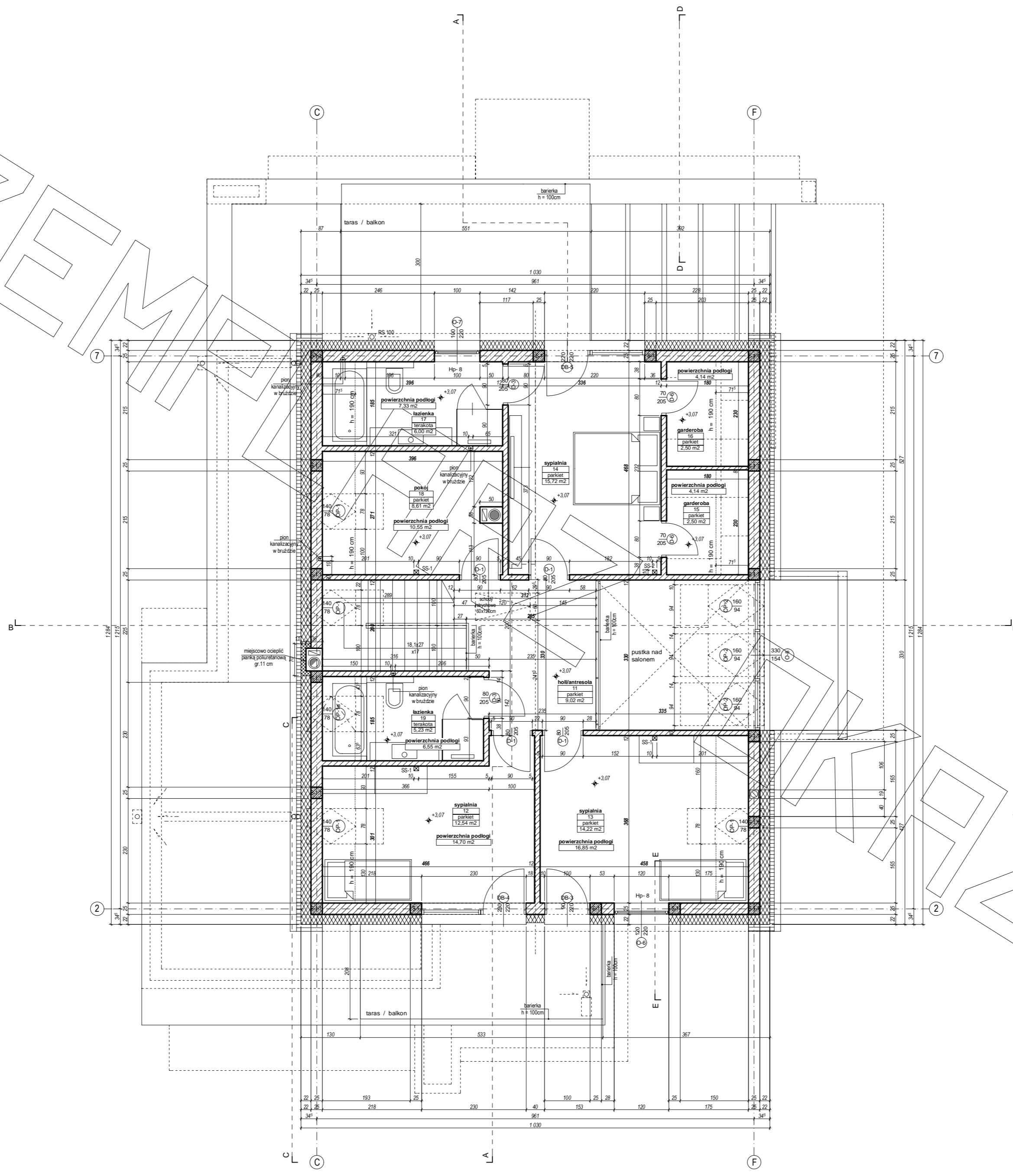

ARCHITECTURA

PRZEKRÓJ A-A

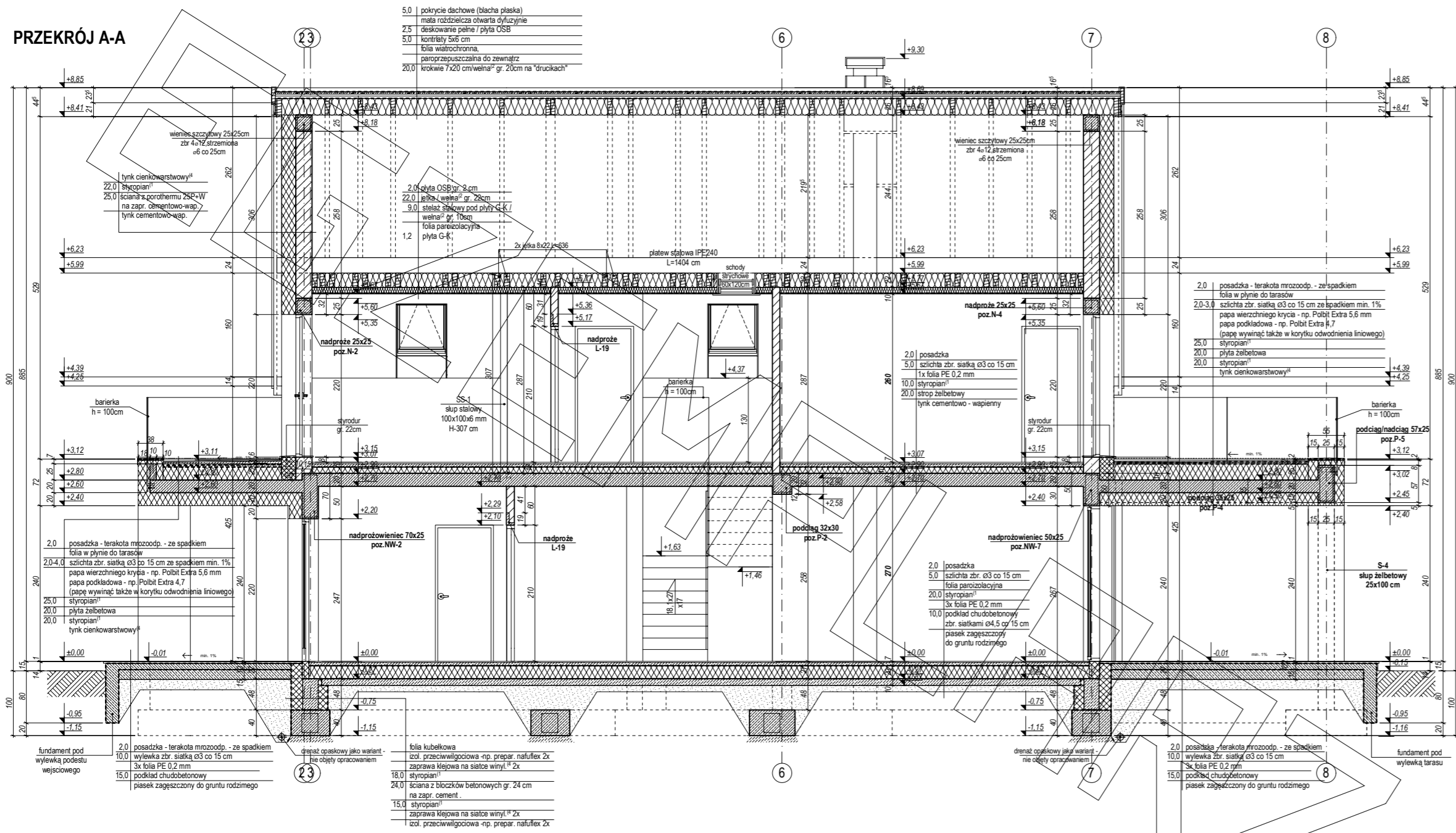

PRZEKRÓJ D-D

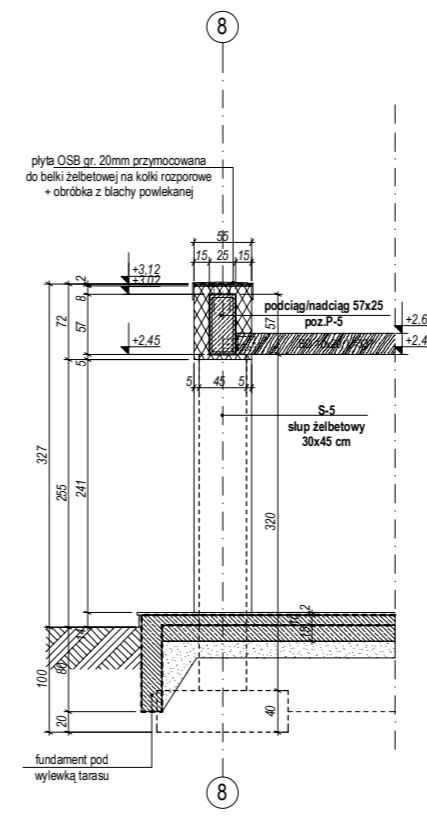

PRZEKRÓJ B-B

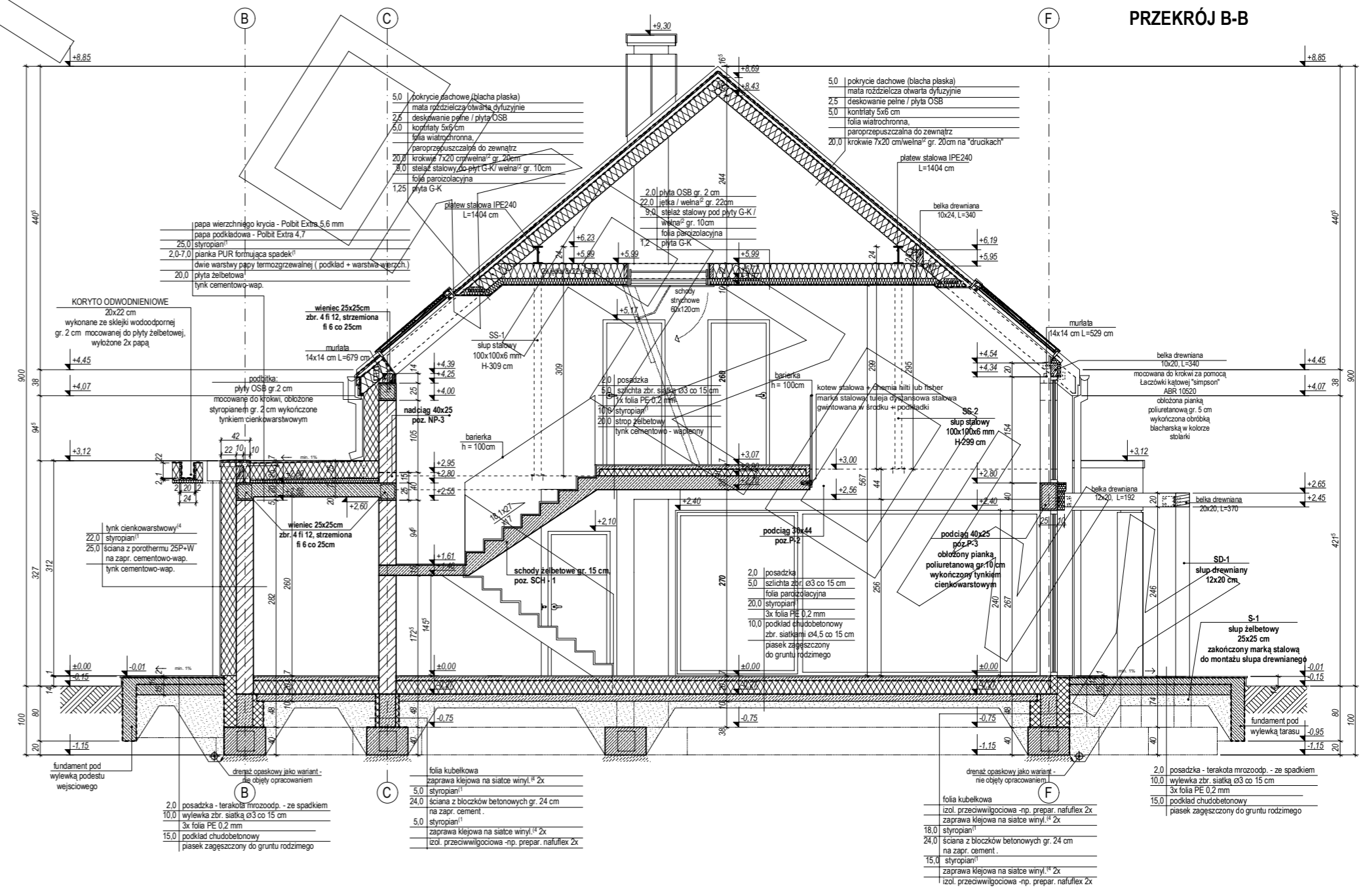



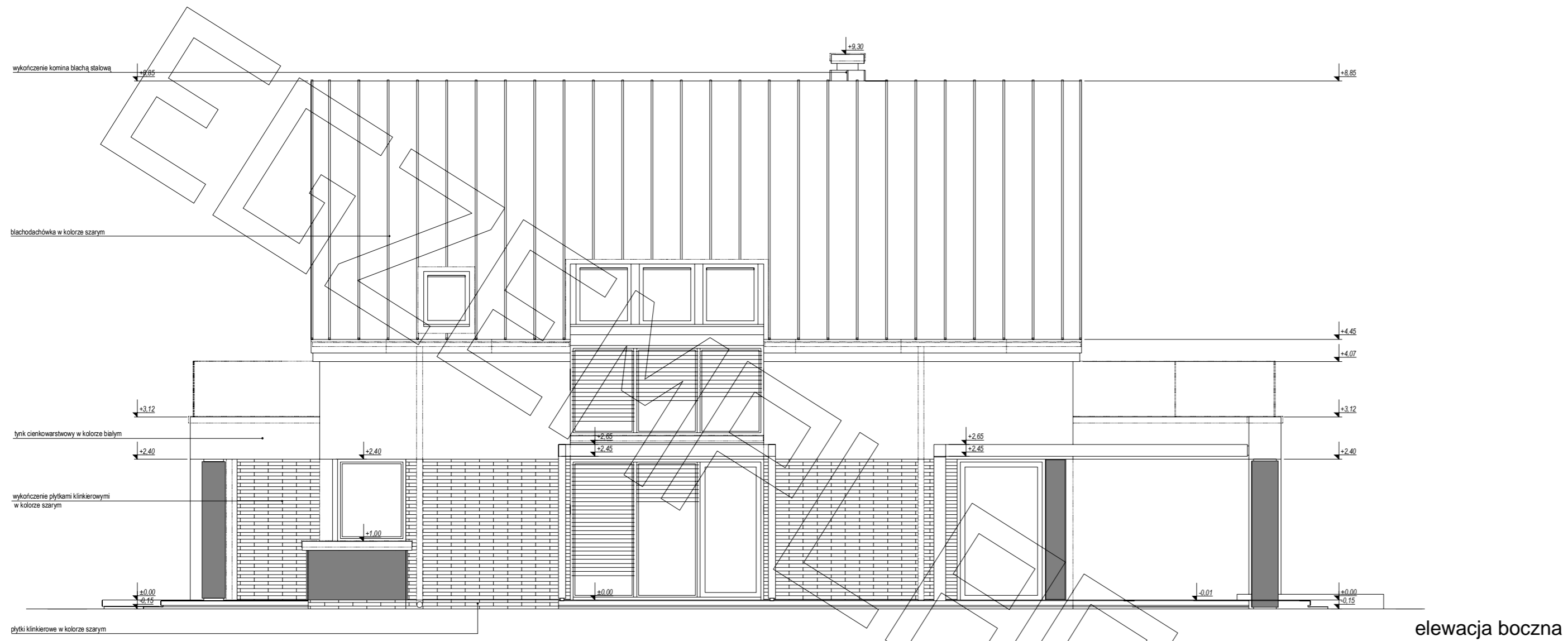

elewacja boczna

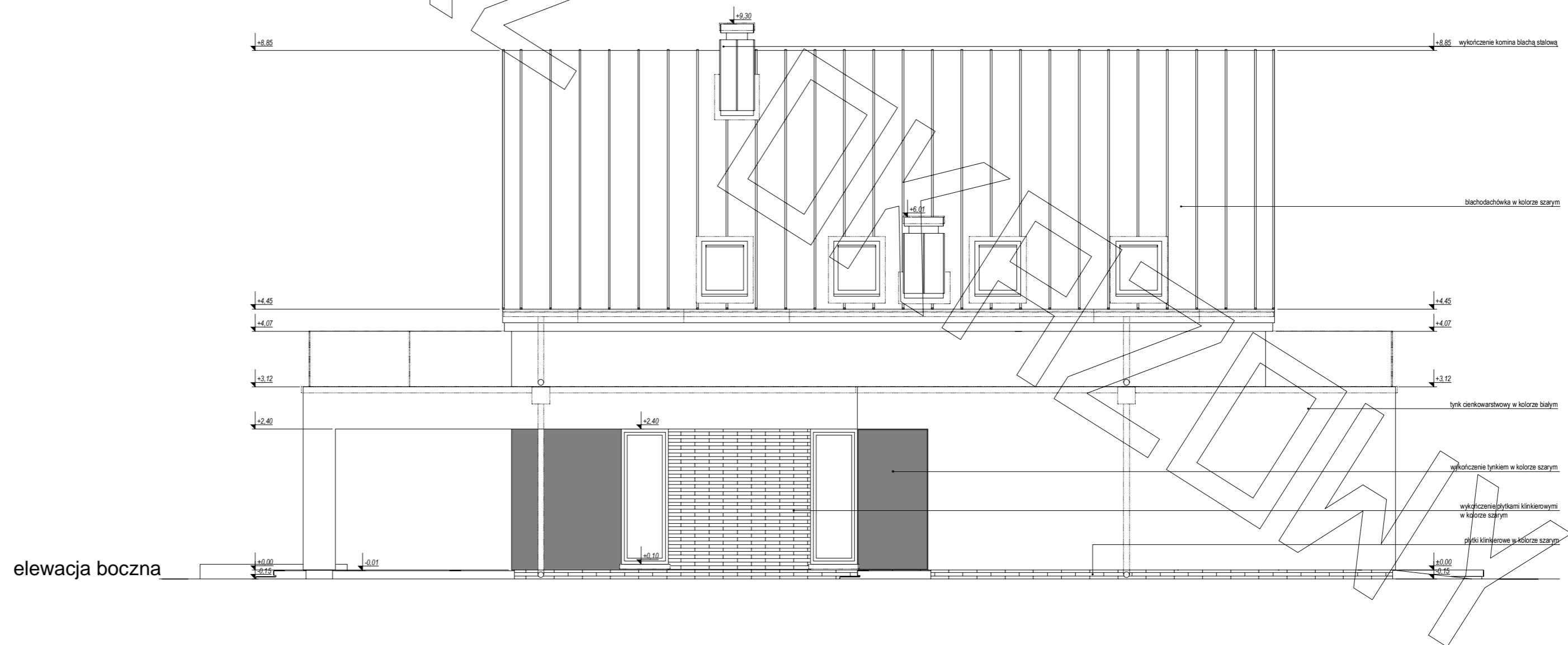

elewacja boczna