

PROJEKT

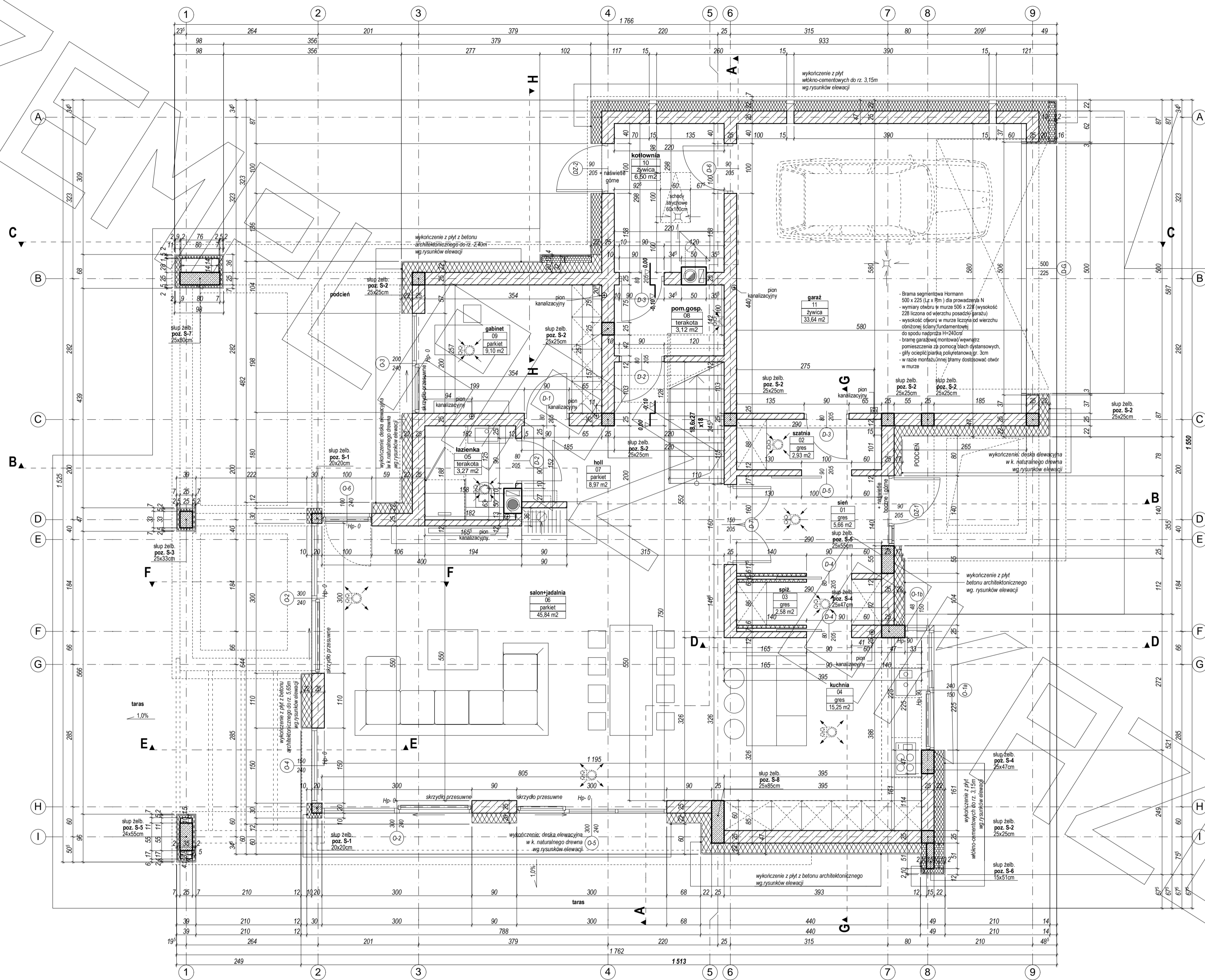

PROJEKT

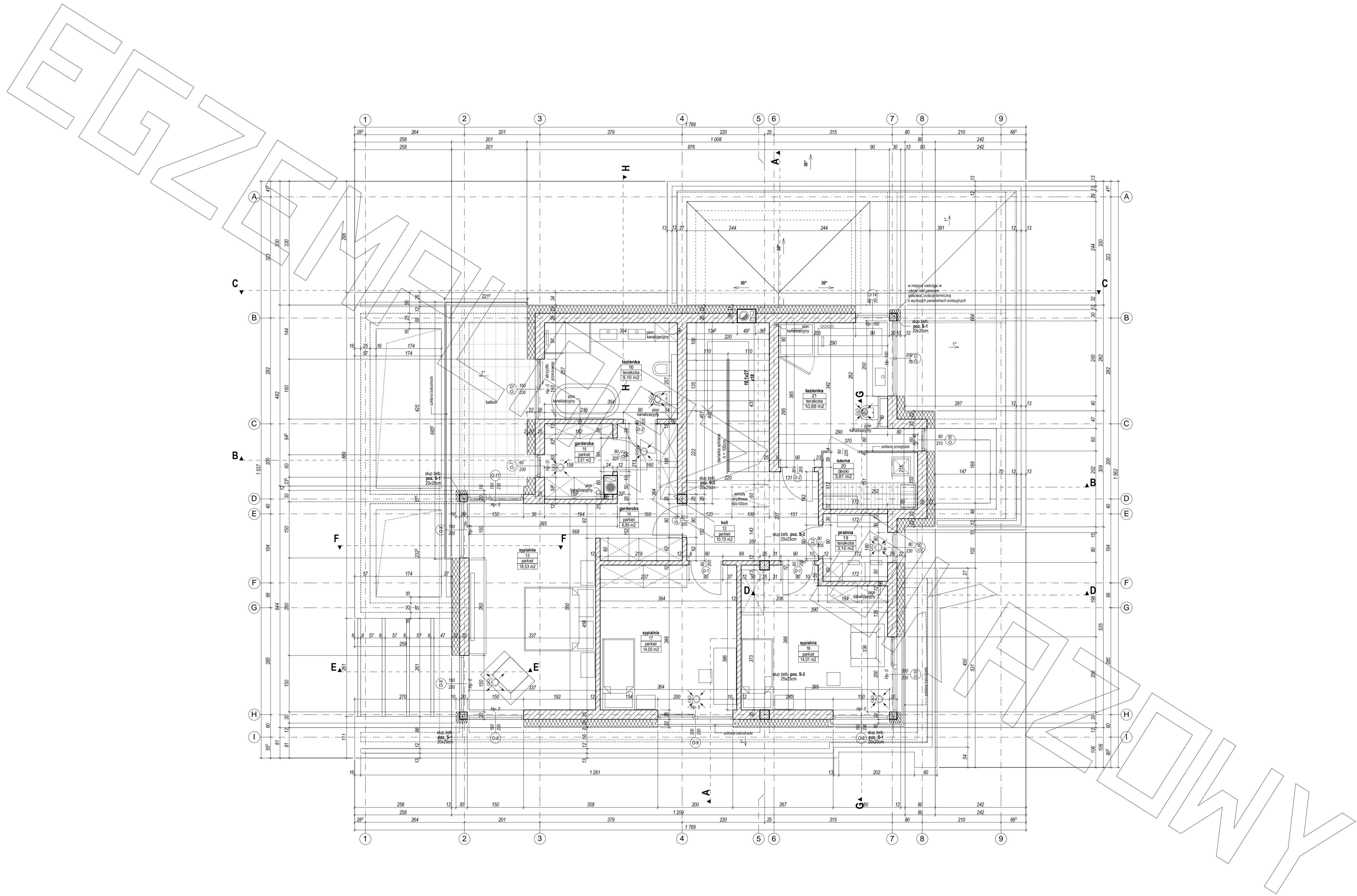

PRZEKRÓJ A-A

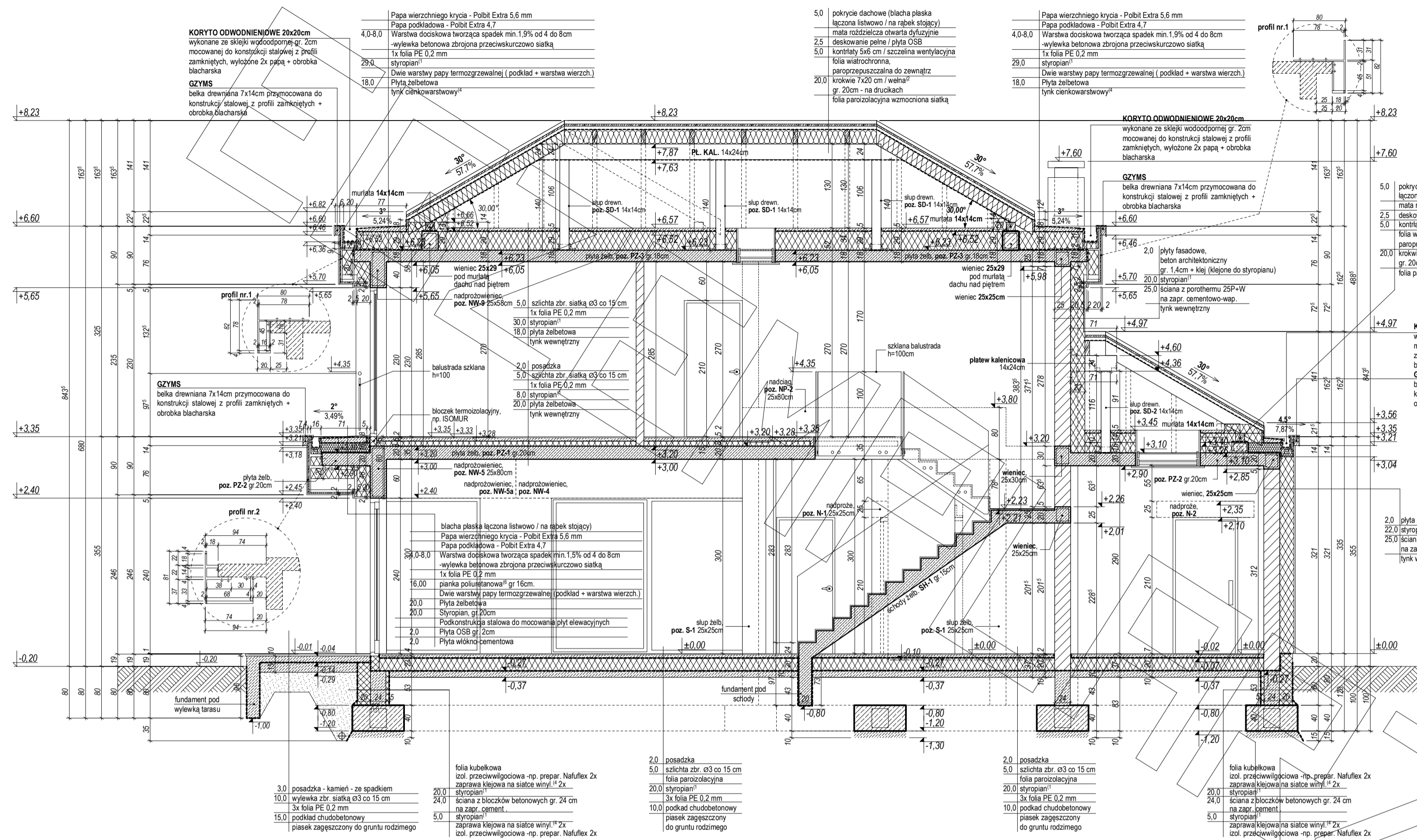

PRZEKRÓJ A1 - A1

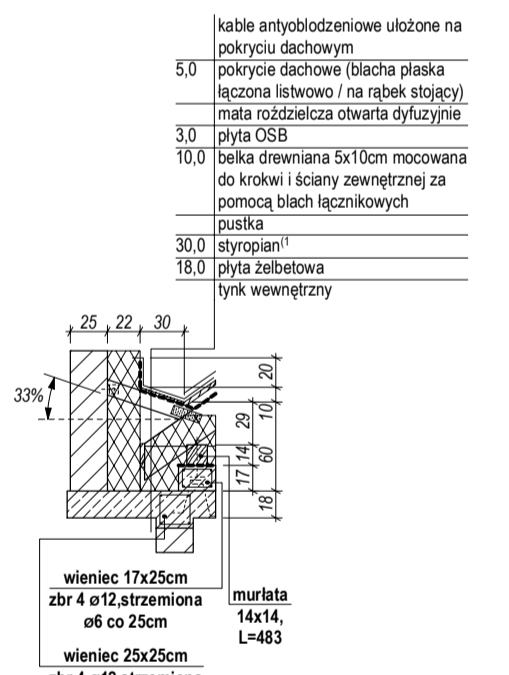

PRZEKRÓJ B-B

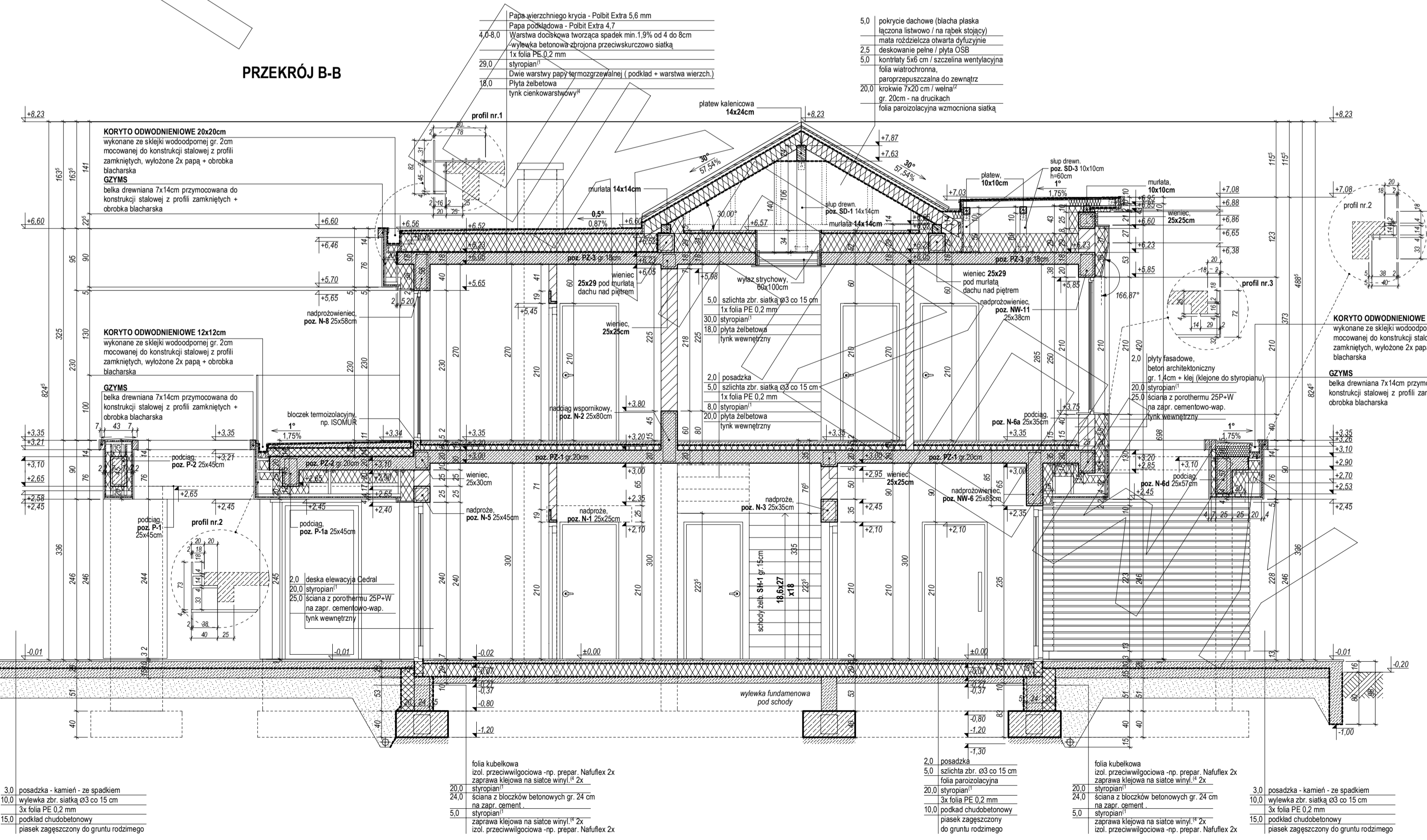

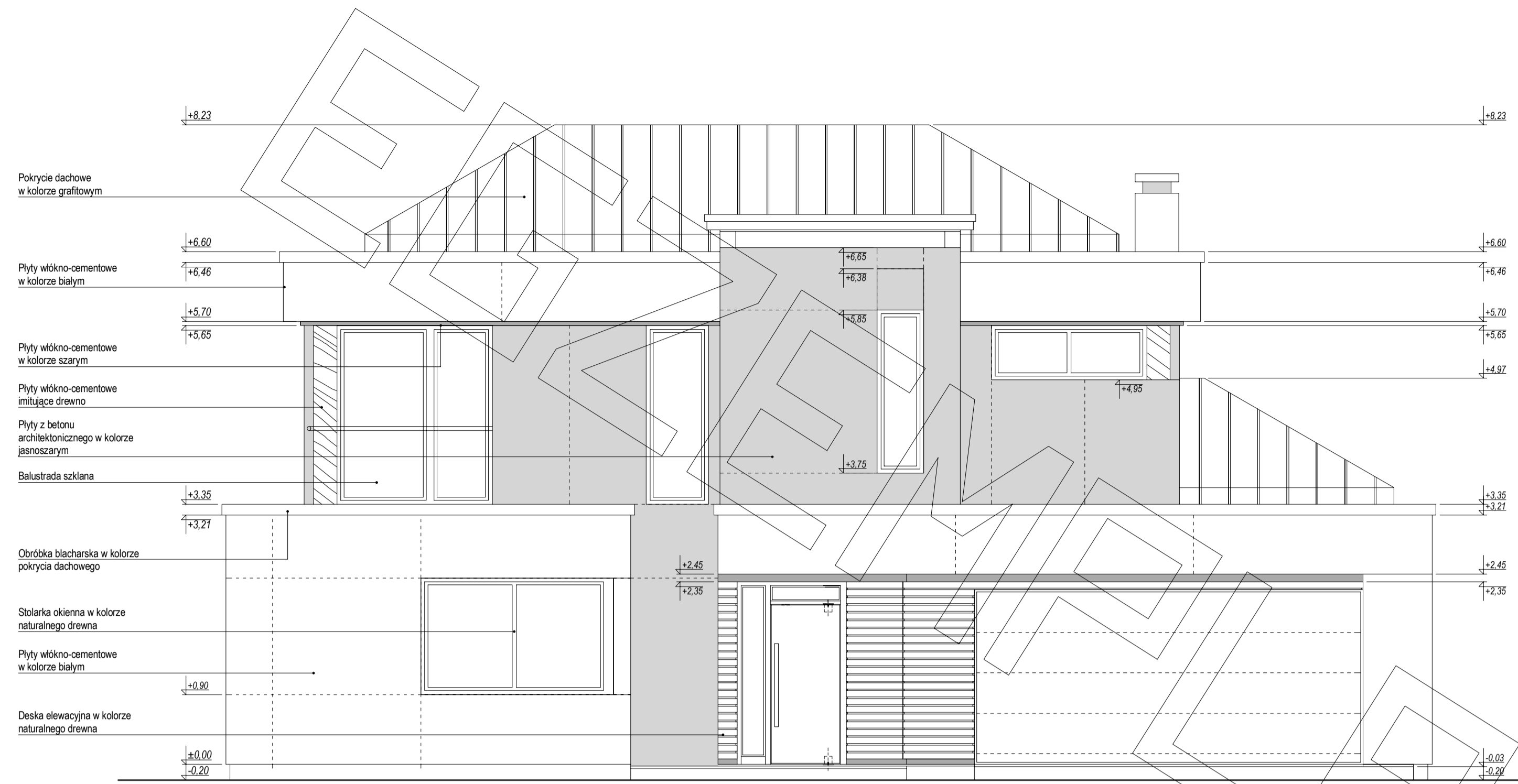

ELEWACJA FRONTOWA



ELEWACJA BOCZNA

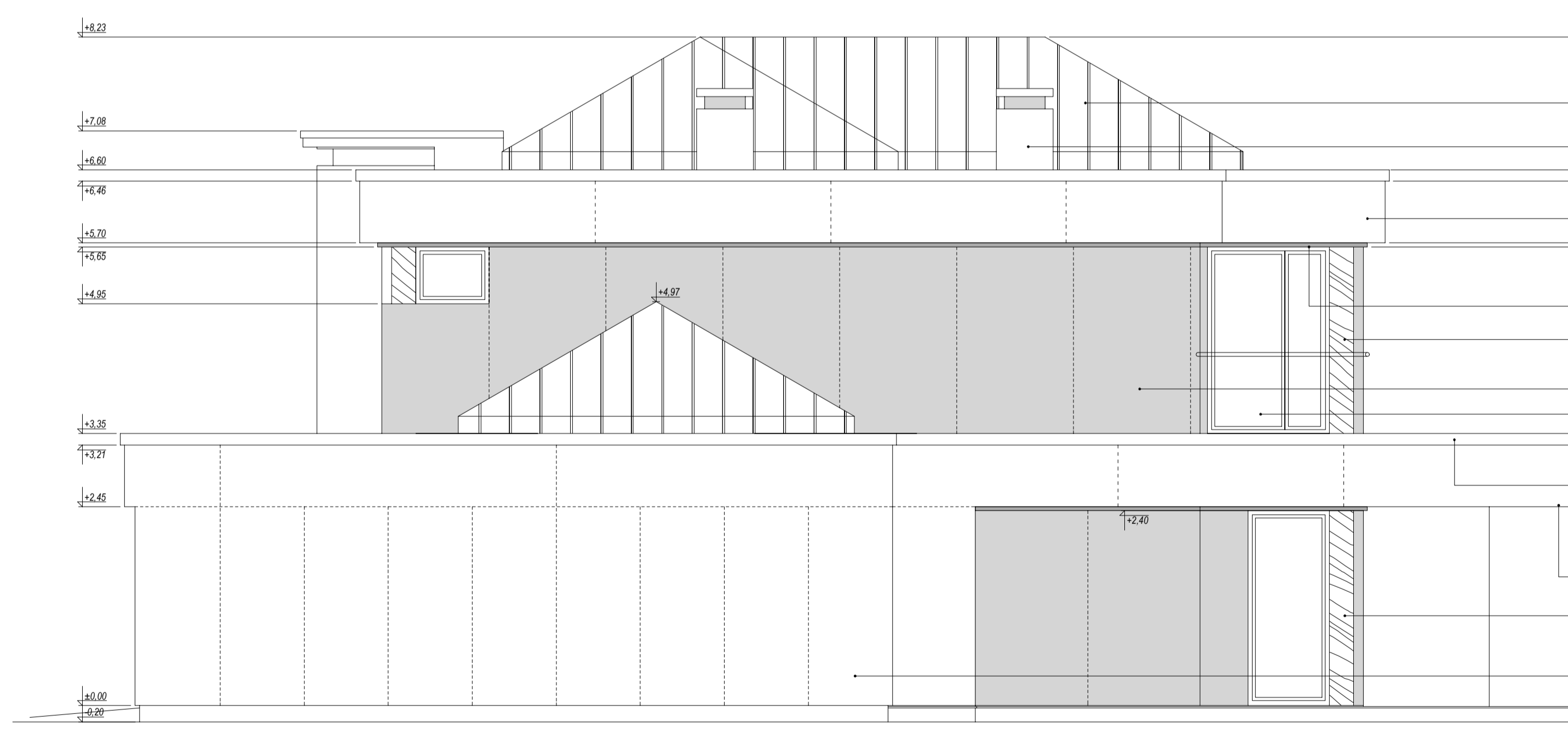

ELEWACJA BOCZNA

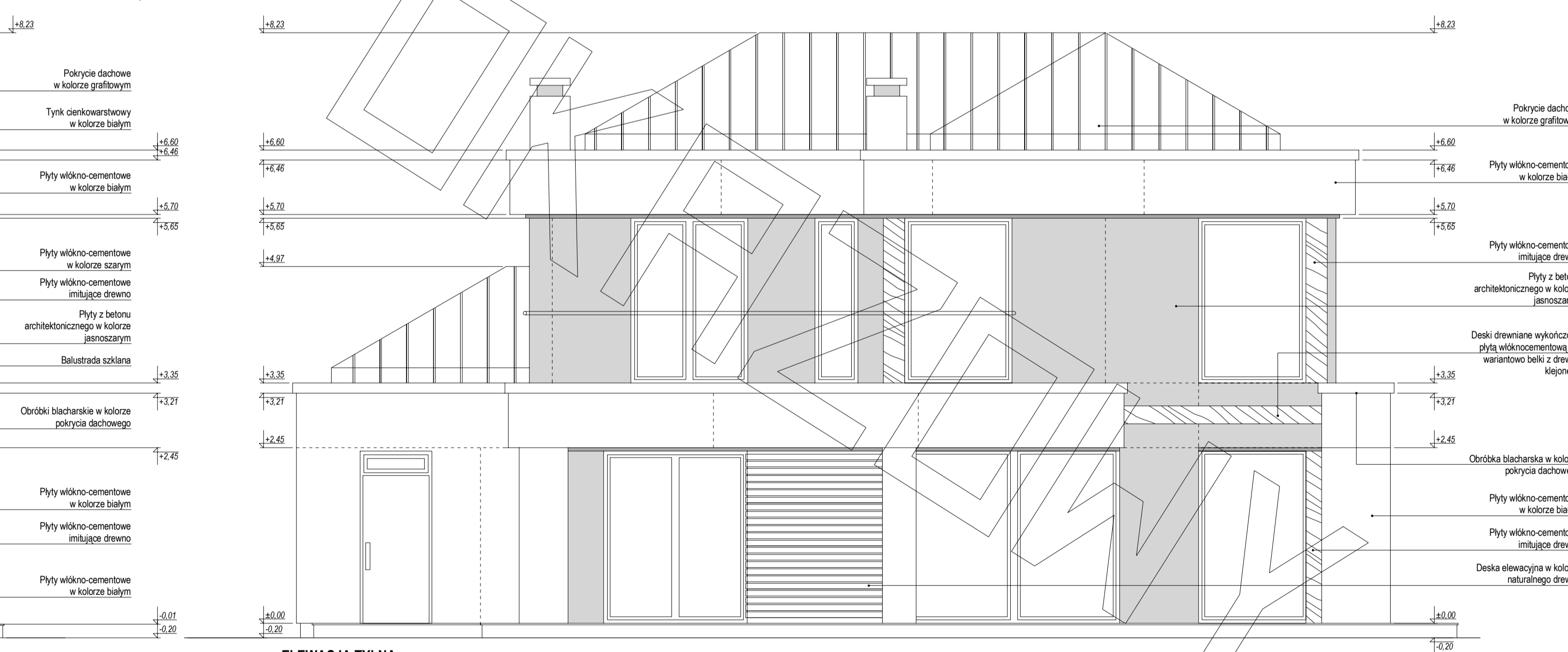

ELEWACJA TYLNA