

RZUT PARTERU

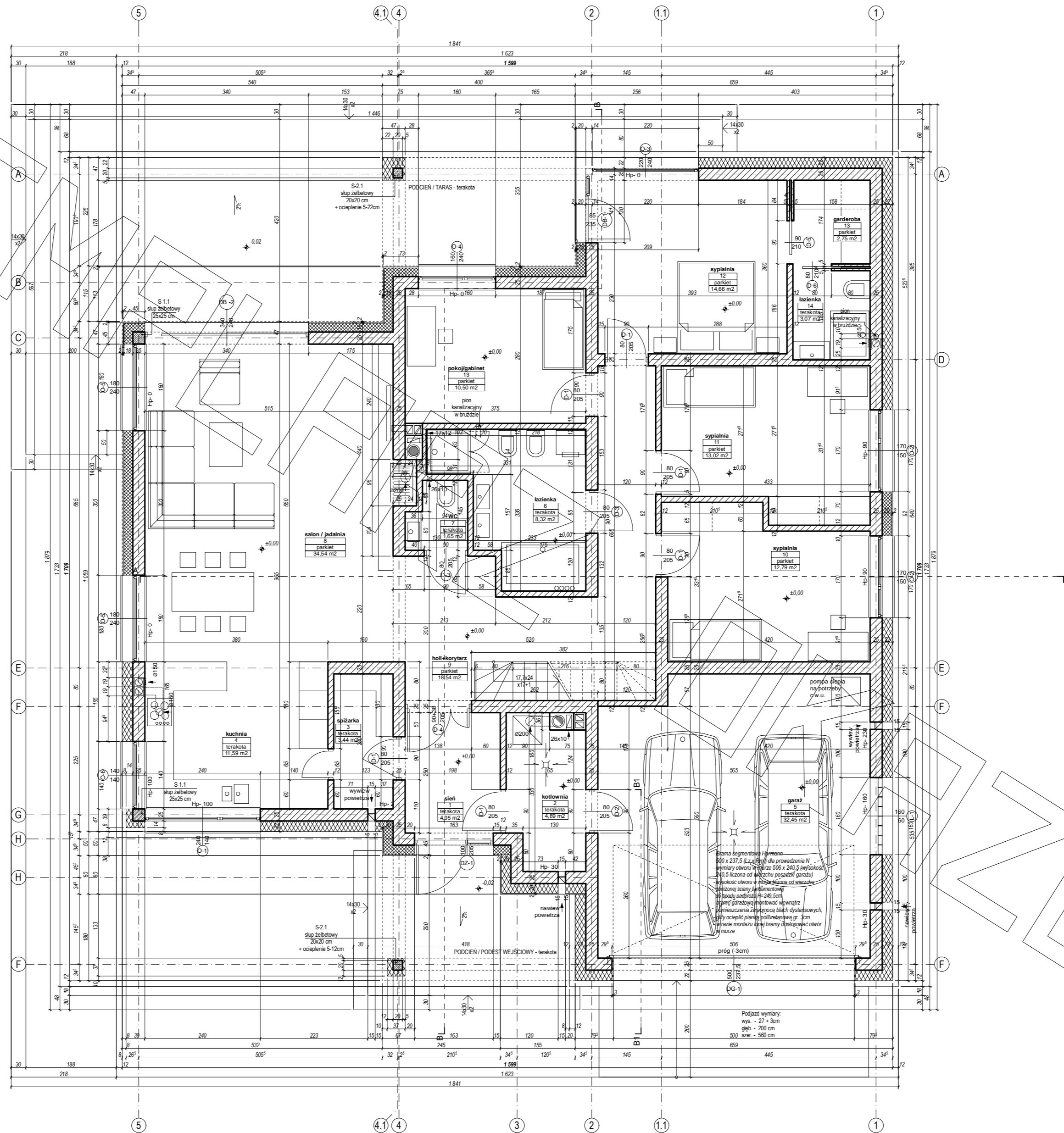

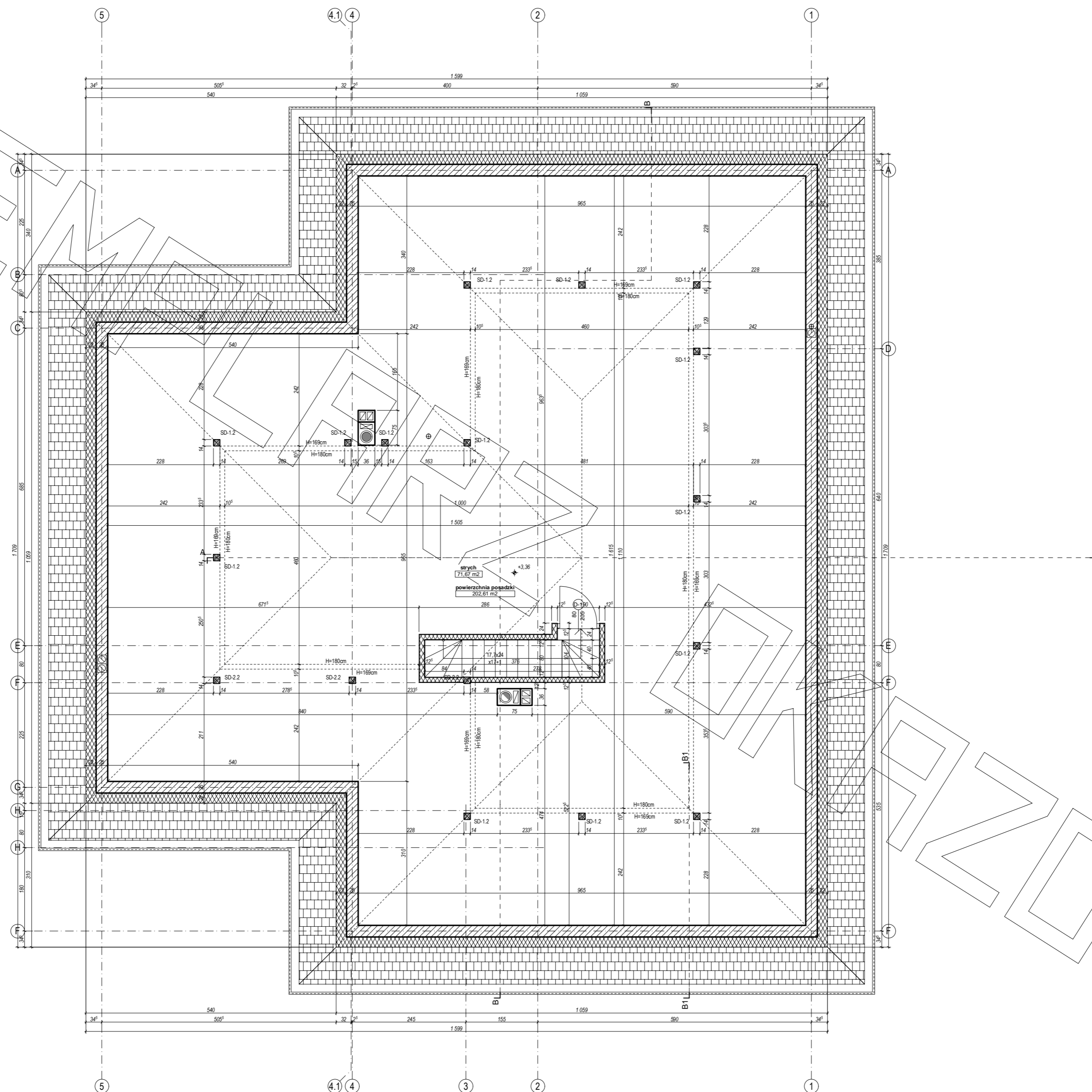

MG PROJEKT

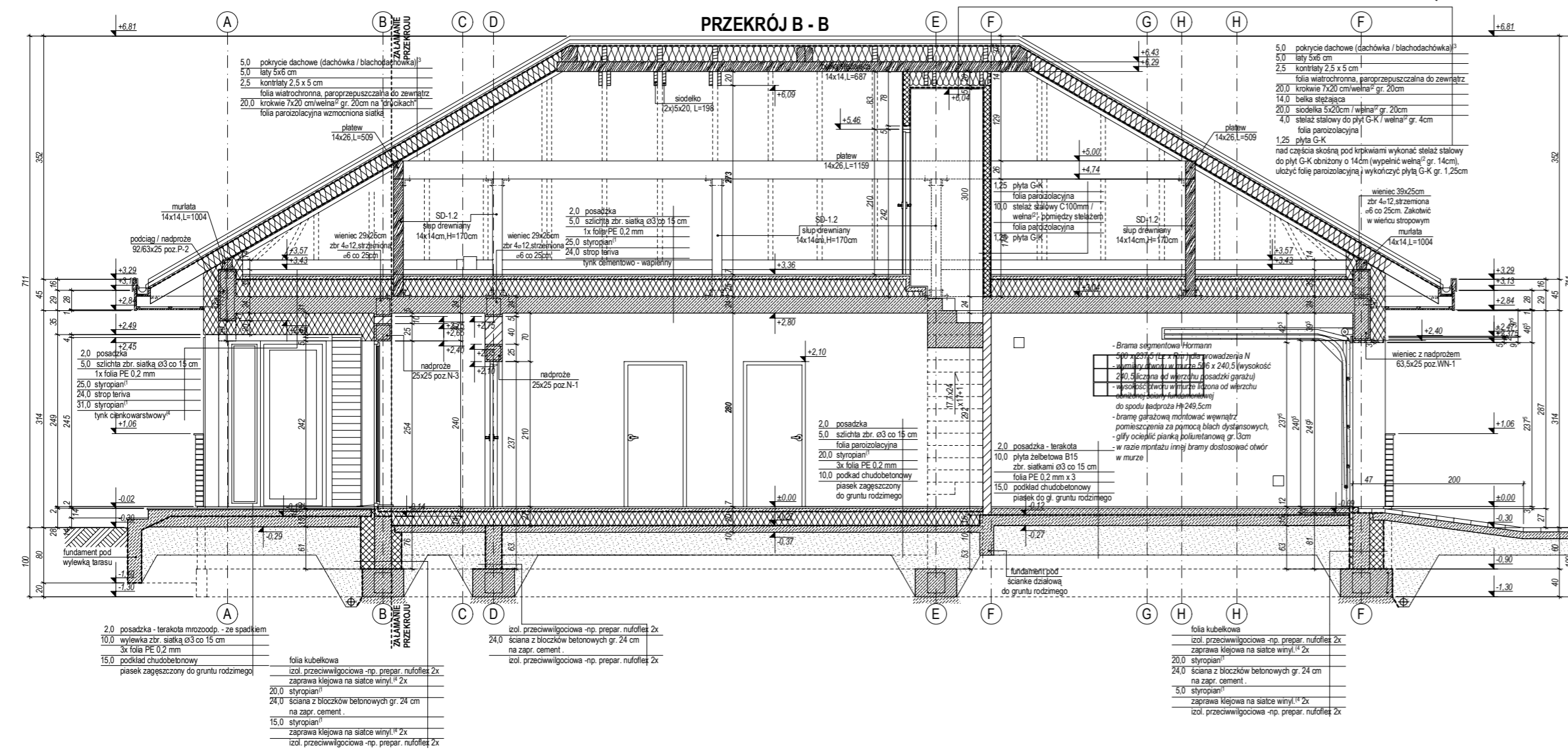
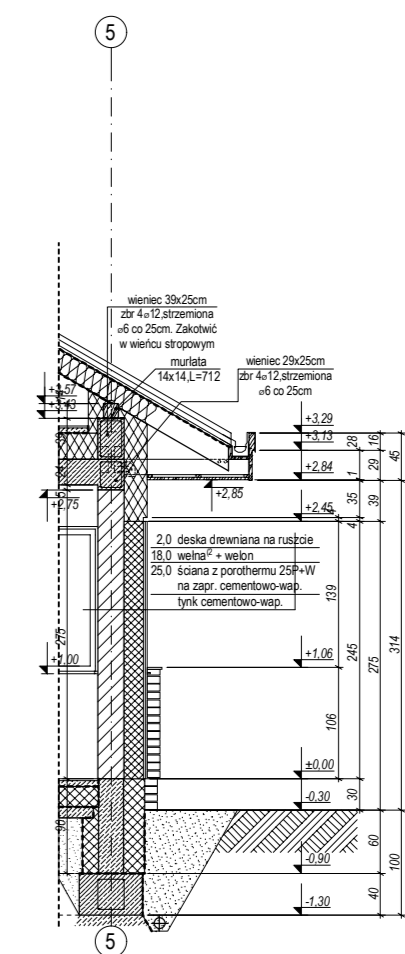
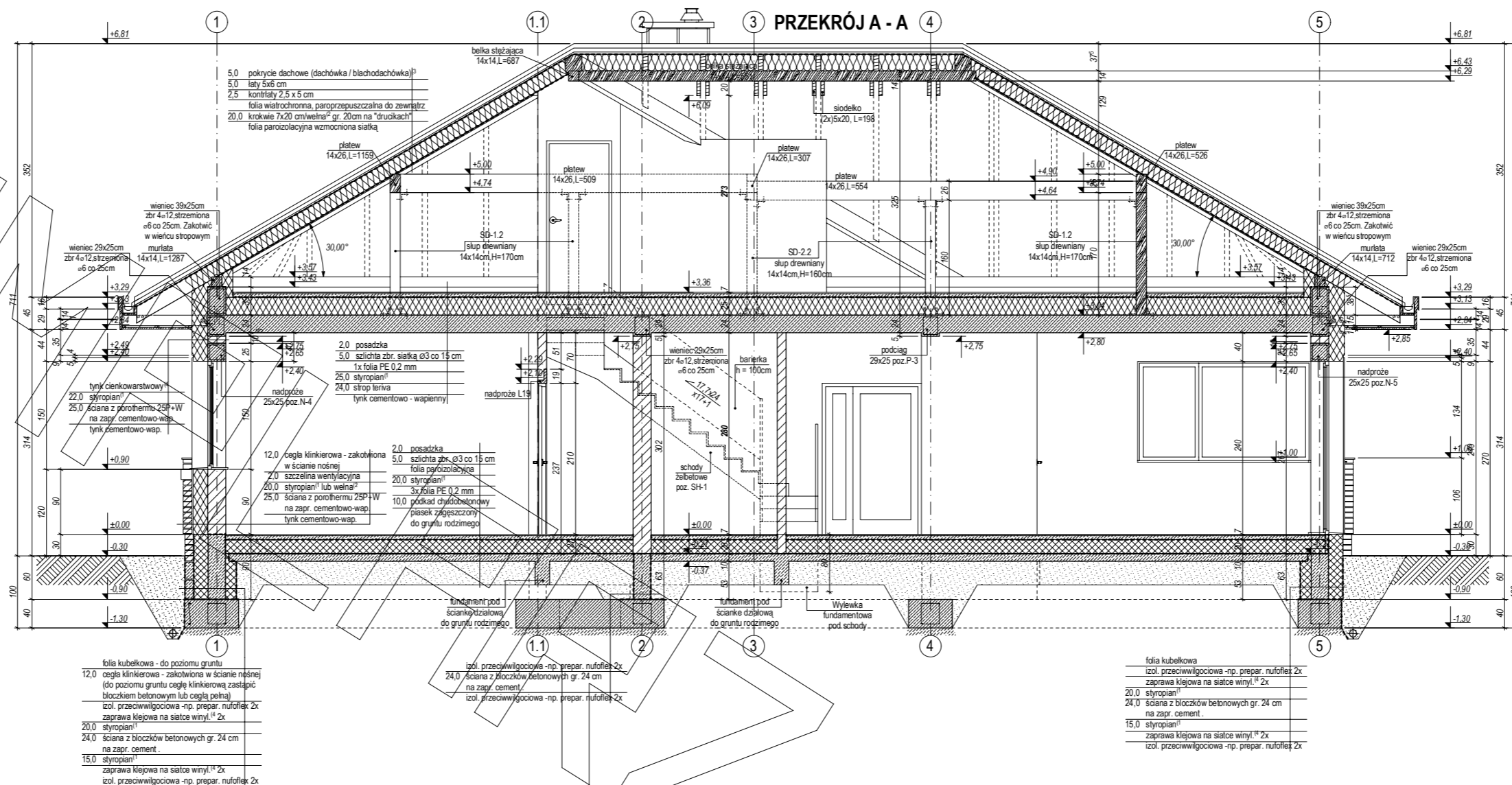

MG PROJEKT

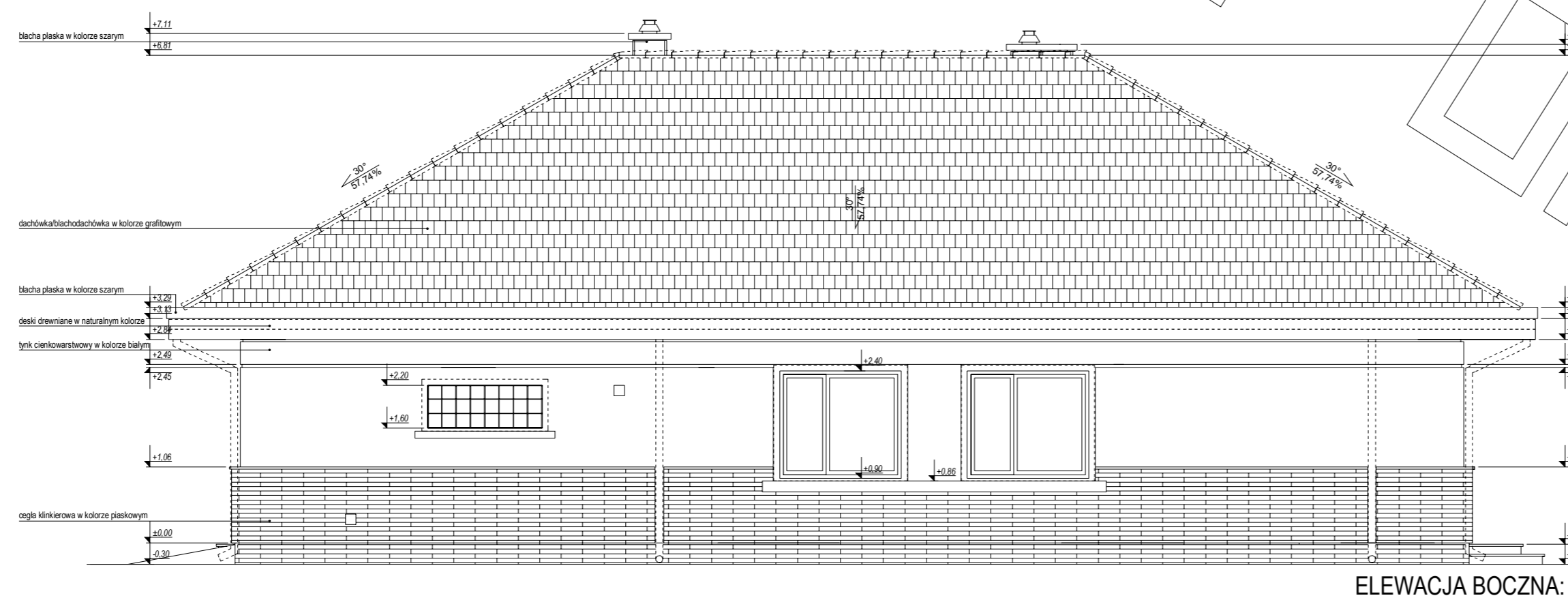
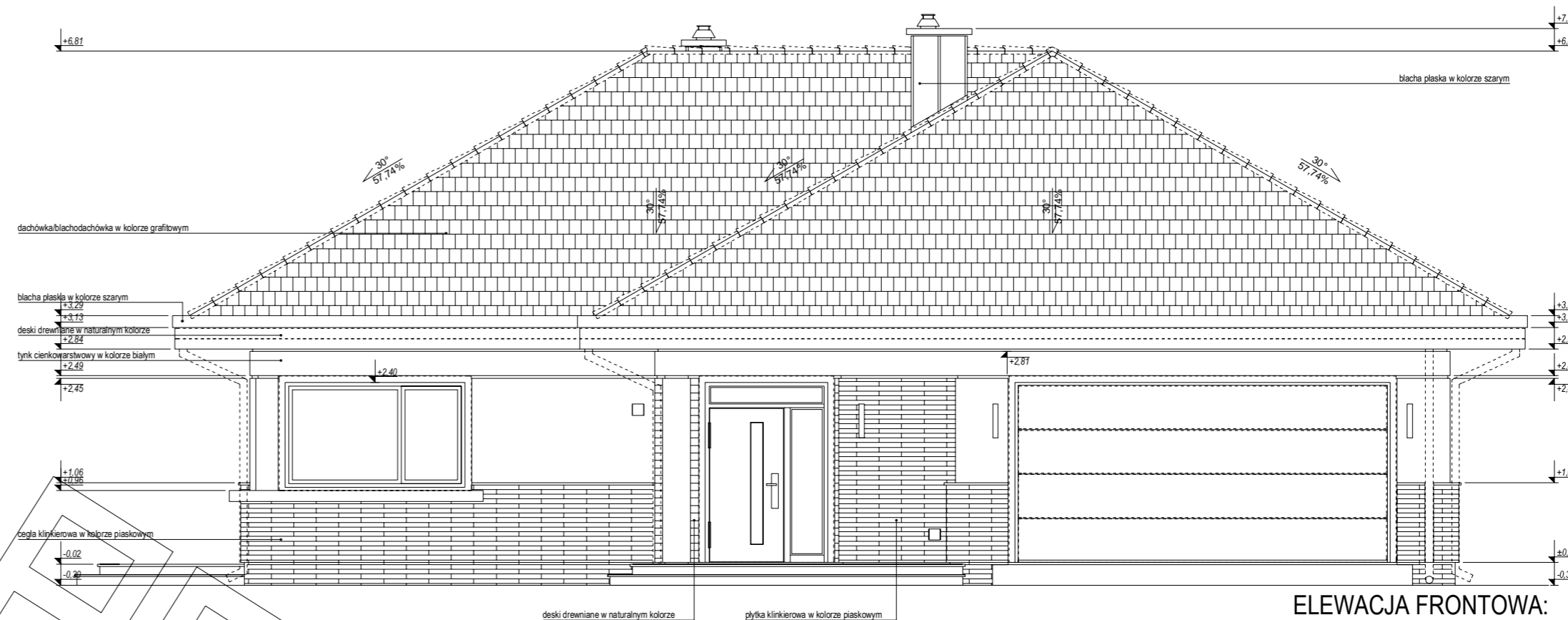

EGZEMPLARZ

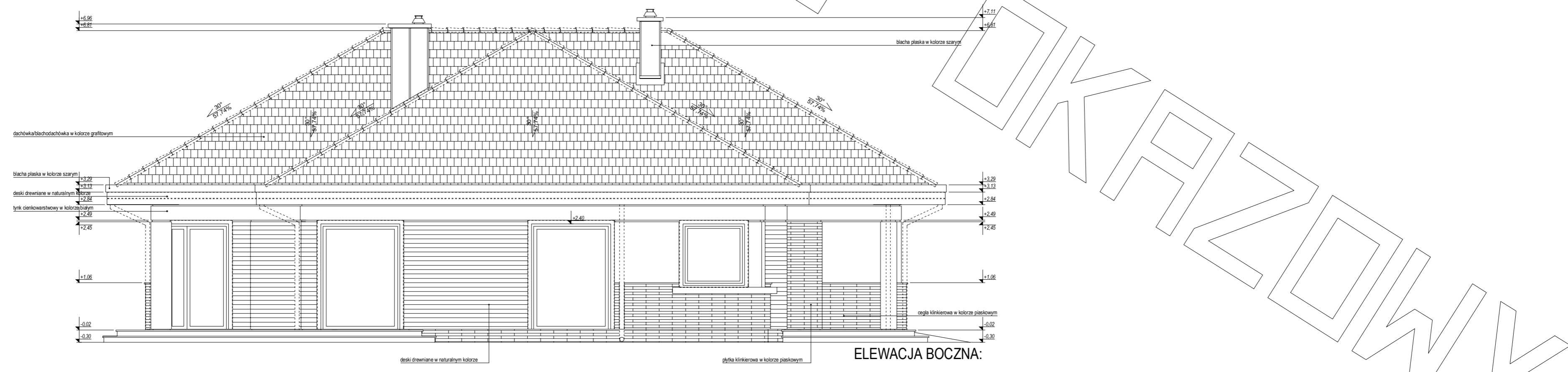
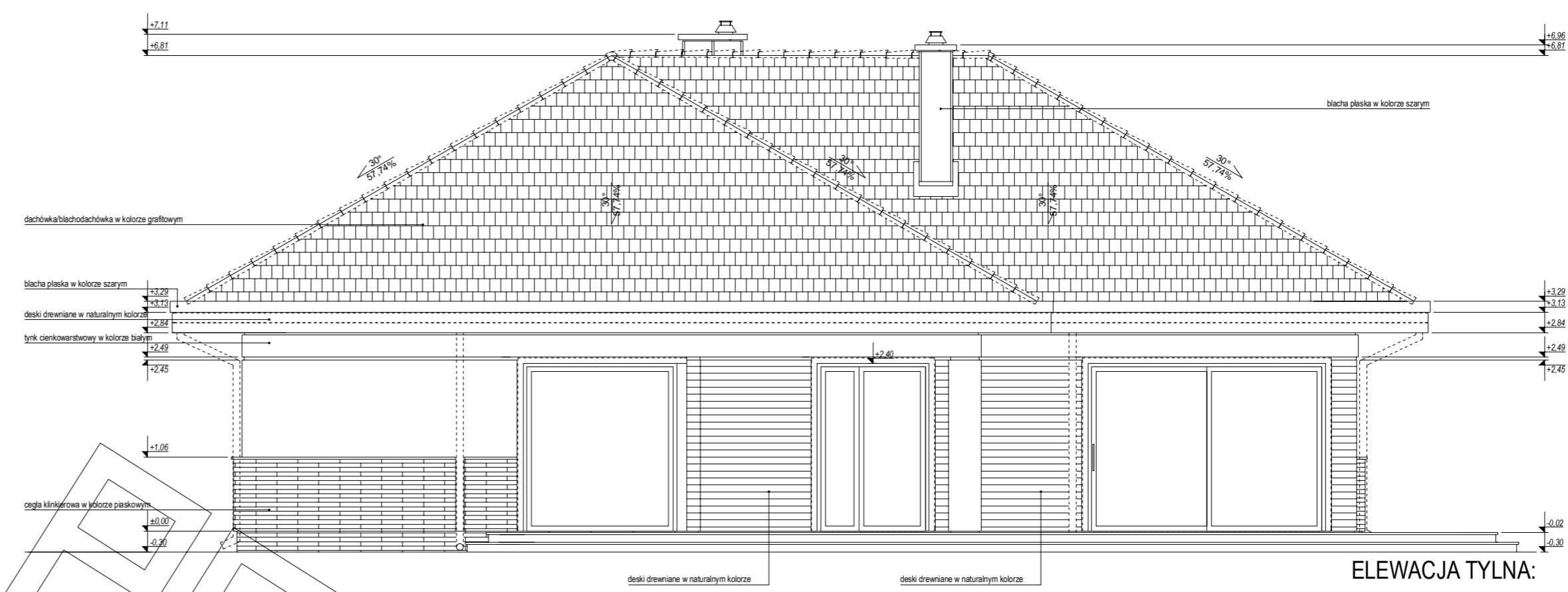

OKRAJOWY